

 Made in Poland. Established 1990.



POL-EKO
Perfect Environment

CATALOGUE PRODUCTS 2023





POL-EKO
Perfect Environment



Ladies and Gentlemen!

Our company is where tradition and modernity meet. Professionalism, practicality, comfort and style are valued by both the market and customers today, but they are also the flagship values we have been committed for over 30 years. Tradition is our strength, experience our teacher, development our future! Our products and services are tailored to your needs and expectations. Customer satisfaction is what motivates us to work harder, to go the extra mile, and to never stop.

Aleksandra Polok-Kowalska





POL-EKO

Perfect Environment

POL-EKO has been present in the Polish market for 30 years.

Highest quality equipment and service we provide ensure your satisfaction.

Our wide range of products and professional solutions will suit the most demanding customers.

We remain open to assist in choosing the right product for your needs, as well as to provide you with customized solutions.

We are your partner in lab analysis and technological processes.

Thank you for your confidence.

POL-EKO team

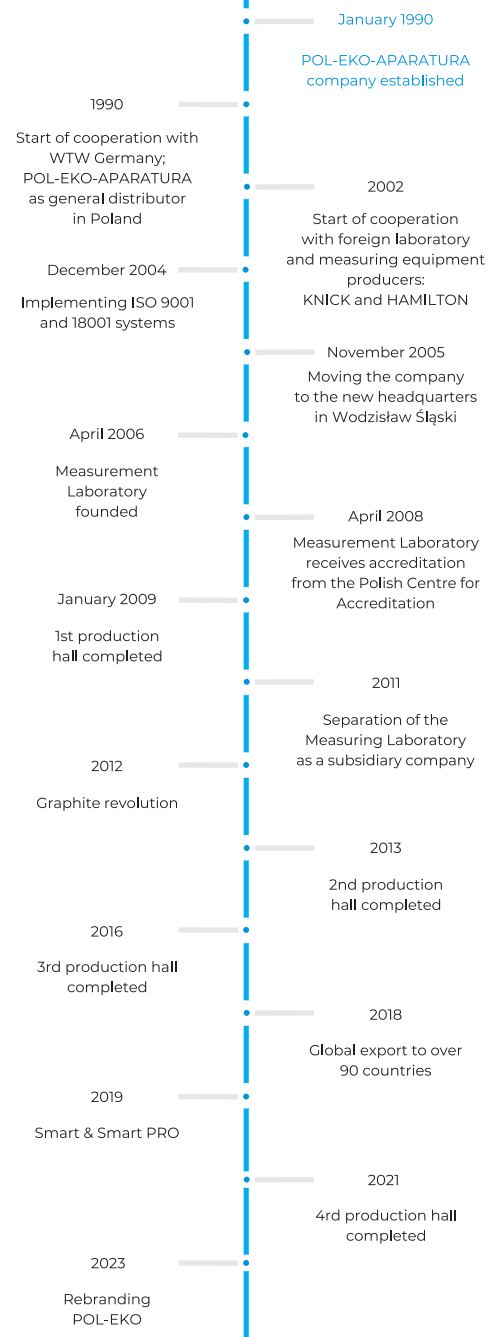

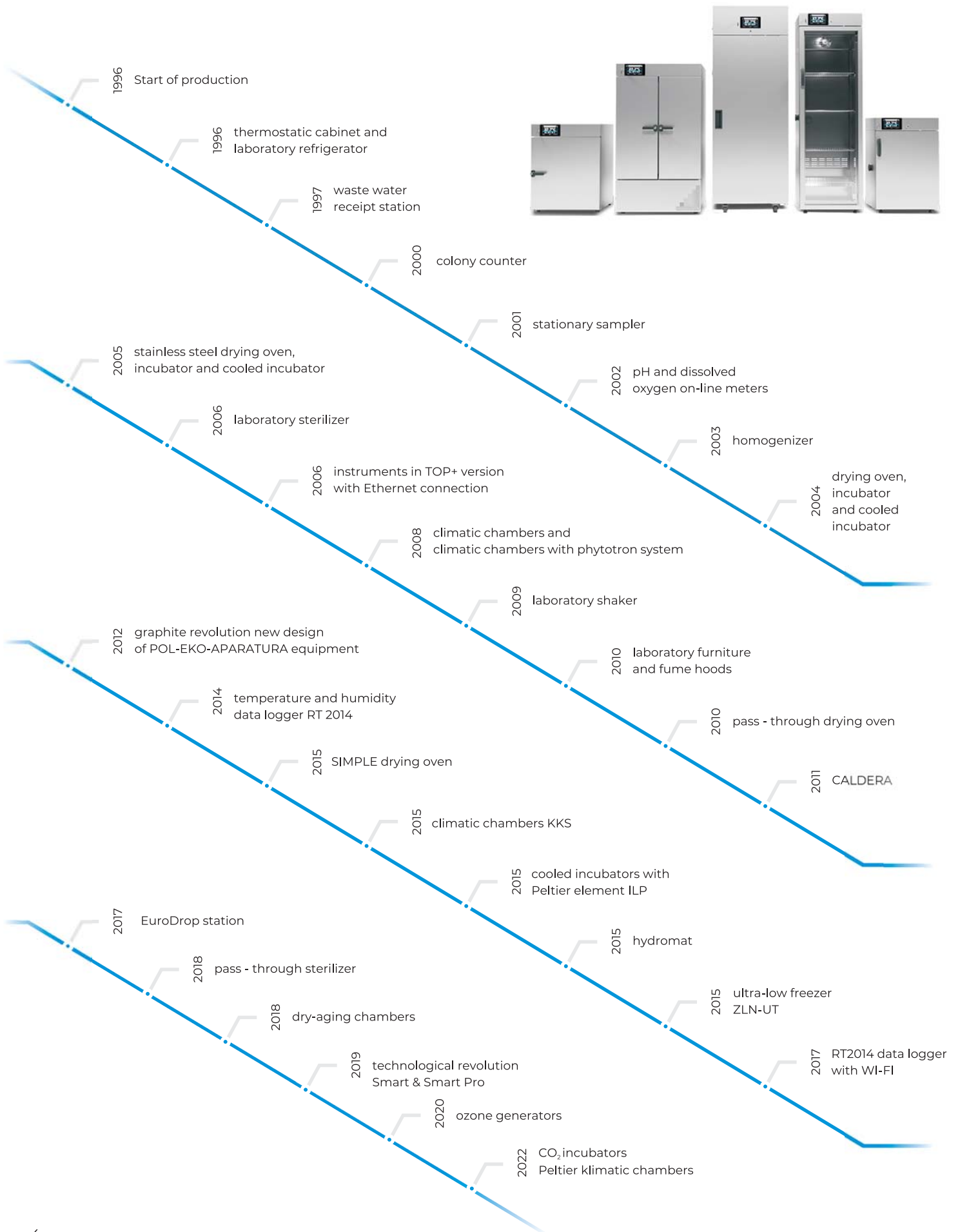

POL-EKO-APARATURA	1 -	We're developing for you	1
I Innovative controllers and model characteristics	7 -	Smart PRO	7
		Smart	13
		Model characteristics	17
II Cooling equipment	19 -	Laboratory refrigerators CHL	20
		Laboratory freezers ZL	25
		Ultra-low freezers ZLN-UT	29
III Cooling and heating equipment	33 -	Cooled incubators ST	34
		Cooled incubators ILW	39
		Peltier-cooled incubators ILP	42
		Incubators with photoperiodic or phytotron system	44
		BOD incubators ST BD	46
IV Heating equipment	47 -	Laboratory incubators CL	48
		Drying ovens SL	51
		Drying ovens with nitrogen blow SLWN	54
		SIMPLE drying ovens	55
		Laboratory sterilizers SR	57
		Pass-through sterilizers SRWP	61
		Warming chambers CALDERA	62
V CO ₂ Incubators	65 -	CO ₂ Incubator ILC	66
VI Climatic and phytotron chambers	70 -	Climatic chambers KK	71
		Climatic chambers with phytotron system	72
		Climatic chambers KKS	74
		Dry-aging cabinets and chambers	78
VII Options and accessories	79 -	Options and accessories	80
		Temperature protection	88
		LabDesk software	90
VIII Laboratory equipment	91 -	RT 2014 data logger	92
		Colony counter LKB	95
		Laboratory shakers LS	96
		Stationary samplers PP 2002+	98
IX Fume hoods	99 -	Fume hoods	100
X Additional equipment	107 -	Disinfection (ozone generators and dispensers)	6
		Non-standard equipment	108
		Emergency power supply ZA	109
		Water and waste water management	110
		Calibration	111

SRW sterilizers for disinfection of face masks

As the biggest Polish manufacturer of laboratory equipment, we would like to present our hot-air sterilizers which can be used for mask decontamination. Special racks for optimal space use available.

SRW sterilizers for disinfection of face masks (see page 58)

Ozone generators

They can be used for air decontamination and refreshment. Ozone can neutralize various microorganisms in our surroundings as it has antifungal, antibacterial and antiviral properties. It also deals with odor, completely neutralizing it.



GO24



GO48



GO CAR

GO24/48 ozone generator basic feature

- Environmental conditions: **for indoor use**
- **Start delay** feature
- Maximum continuous operating time: **90 min**
- Minimum rest period after 90min cycle: **20 min**
- Maximum cubic capacity of sterilized areas: **165/420 m³**
- Maximum cubic capacity of the sanitized room: **330/840 m³**

Available ozone generators for car disinfection.

Manual and automatic dispensers, stainless steel or powder coated sheet

Touch-free dispensers with proximity sensors, foot pedal or manual

Available versions

- automatic for AC power supply and a 5L bottle
- manual with a foot pedal and a 5L bottle
- hand-operated for wall or stand installation
 - with a basket for a 1l bottle
 - with a basket for a 0,5l bottle
 - bottle thread-mount for a 1l bottle
 - bottle thread-mount for a 0,5l bottle





INNOVATIVE CONTROLLERS AND MODEL CHARACTERISTICS

Smart PRO

Smart PRO controllers are direct followers to the TOP+ controllers and will be available for the KK climatic chambers, IL cooled incubators, SL drying ovens, CL laboratory incubators, as well as the ST cooled incubators, CHL laboratory refrigerators, ZL laboratory freezers and ZLN-UT ultra-low freezers. Smart PRO has a microprocessor-based PID temperature controller with a large (7") colour touch panel and intuitive and user-friendly software.

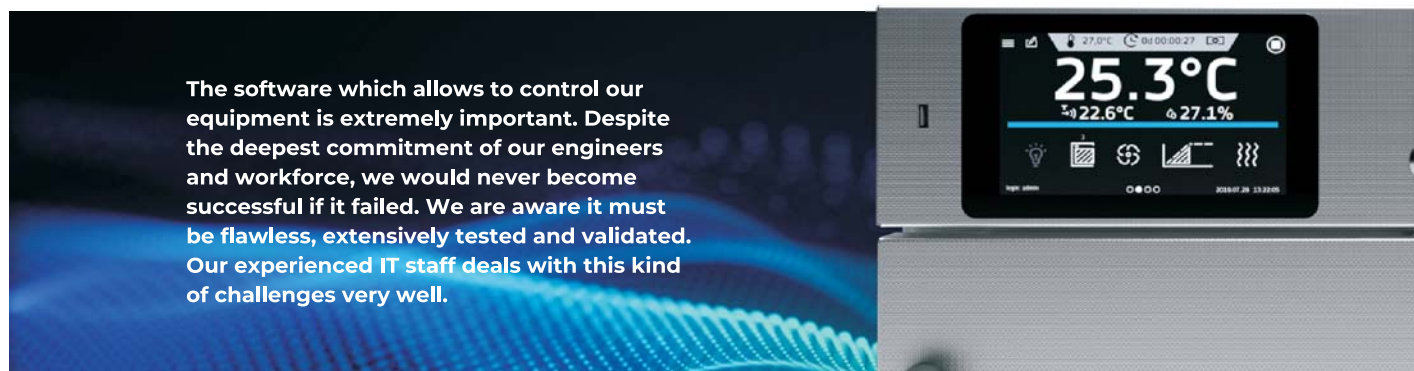

Getting started

During the first boot, the Smart PRO controller will automatically ask if you want to save the "Download" folder (instruction manual and additional LabDesk software) on the USB flash drive.



Types of accounts and their limits

Smart PRO controllers have several types of user accounts.

Super Admin - this account has not limits. It has access to the program management menu and to all settings.

Admin - it has access to program management menu, where you can create or edit programs, check their statistics, check the event history and information about the system.

User – it has access to programs shared to him by other users and run them, check statistics, event history and system information. The user cannot create his own programs/schedules and stop those he did not start himself. The program started by the user can be stopped by the Super Admin.

■ 7" colour touch panel Smart PRO guarantees intuitive and comfortable operation

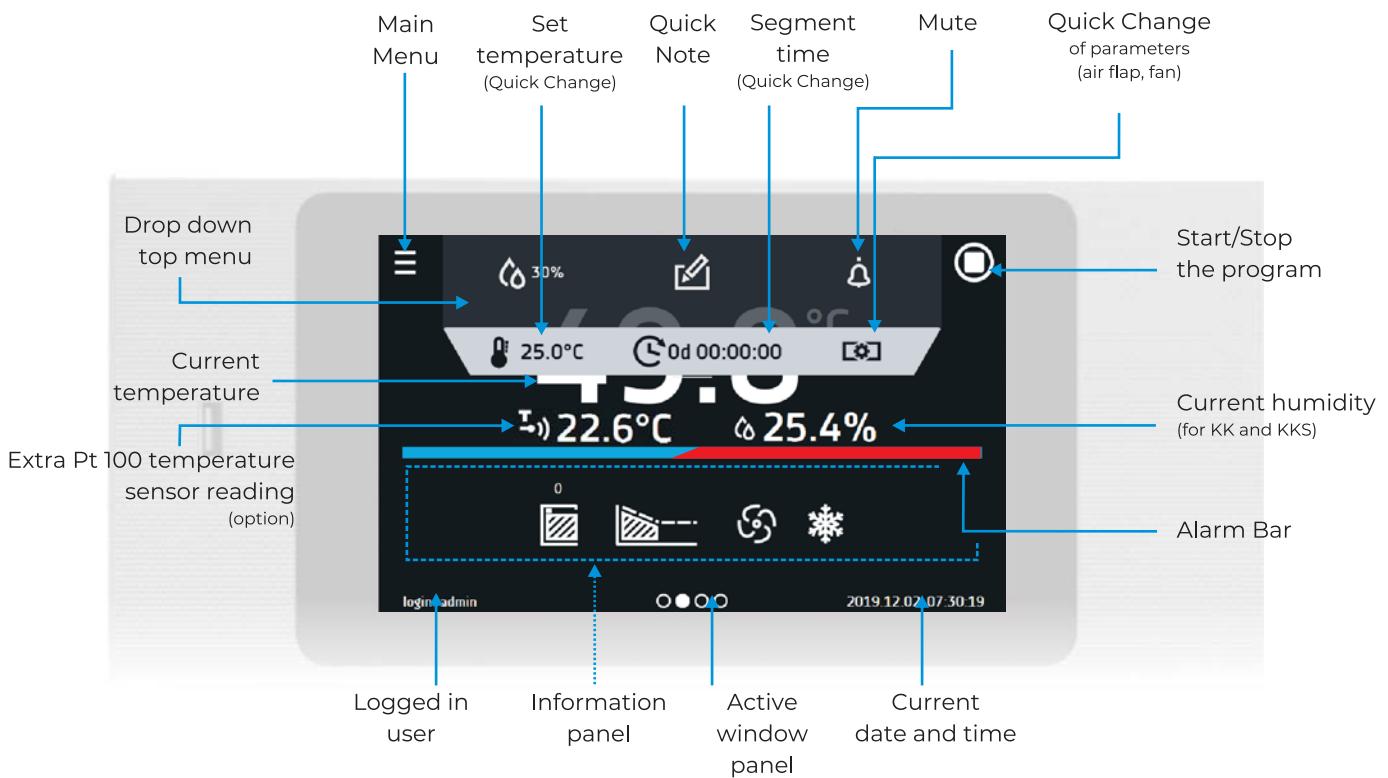

■ Advantages of the Smart PRO controller

- large (7"), clear, full colour touch screen
- LAN, USB ports and WiFi for communication and data transfer
- multi-segment time and temperature programs
- overview of data in tabular and graphic form
- visual and audible alarm
- administration functions for easy management
- password protected log-in
- internal memory for programs and data storage
- operating with gloves on
- event registry with user notifications
- LabDesk software and instruction manual for direct download
- Alarm Bar – instant visual information about chamber status
- Quick Note – user can save text notes (50 characters) in Smart PRO controller memory
- Quick Change of parameters: temperature, humidity, time, air flap and fan (according to model)



Touch screens of the Smart and Smart PRO controllers can be operated with latex gloves!

Quick Note - GLP supporting feature

Quick Note - while operating the equipment, the user can save messages in the memory, for example, about inserting a new sample or about any changes etc. To enter the message the user must be logged-in. The entered notes can be seen in the event log, they are symbolized by a green envelope icon.

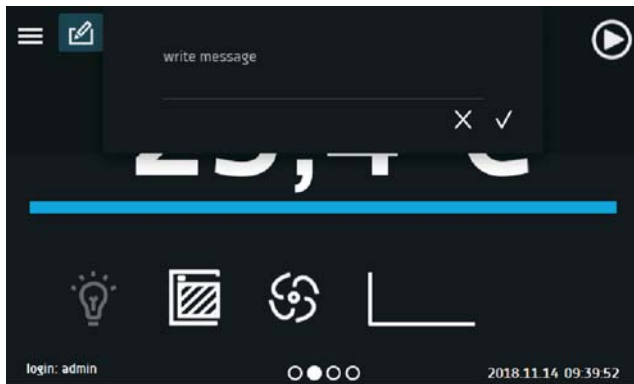

date	name	code
2018.11.14 09:40	User Message	3.01.0.1.001
2018.11.14 09:36	Program deleted	2.01.0.1.023
2018.11.14 09:35	Program Stop	2.01.0.1.008
2018.11.14 09:34	Program Start	2.01.0.1.007
2018.11.14 09:21	User added	2.01.0.1.019
2018.11.14 09:21	User added	2.01.0.1.019
2018.11.14 09:20	User deleted	2.01.0.1.021
2018.11.14 09:20	Deleted Measurement	2.01.0.1.017
2018.11.14 09:20	User deleted	2.01.0.1.021

Quick Note advantages

- support Good Laboratory Practice
- messages saved in Smart PRO events log
- can be shown on reports in LabDesk software
- internal information in laboratory
- control/supervision of the process



■ Programming Smart PRO in 4 steps logged as: Admin

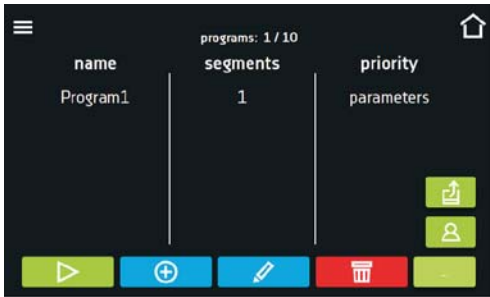

Step 1

Tap “programs” icon in main menu to enter Programs screen. Here you can manage your programs and also upload them from a USB flash drive.



Step 2

Tap “+” icon to add a new program, then insert the program name, the number of segments etc. Tap blue segment icon to configure segments.

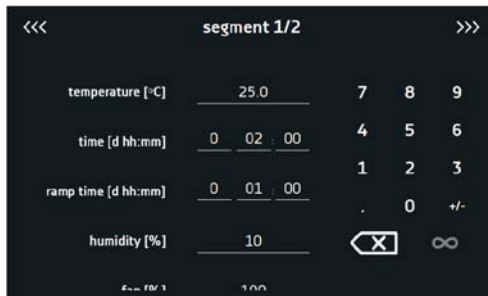

Step 3

Configure all segments using numeric keypad. To move onto the next segment slide the segments number or tap arrows.



Step 4

Check all your settings in the summary and tap save. Your program is ready to use.

■ Programming via LabDesk

You can create programs in LabDesk software and load them to Smart PRO controller via LAN cable, WiFi or using a USB flash drive.

■ Quick Change - quick and easy change of parameters

Quick change of the set parameters is only possible in the program started by the same user.

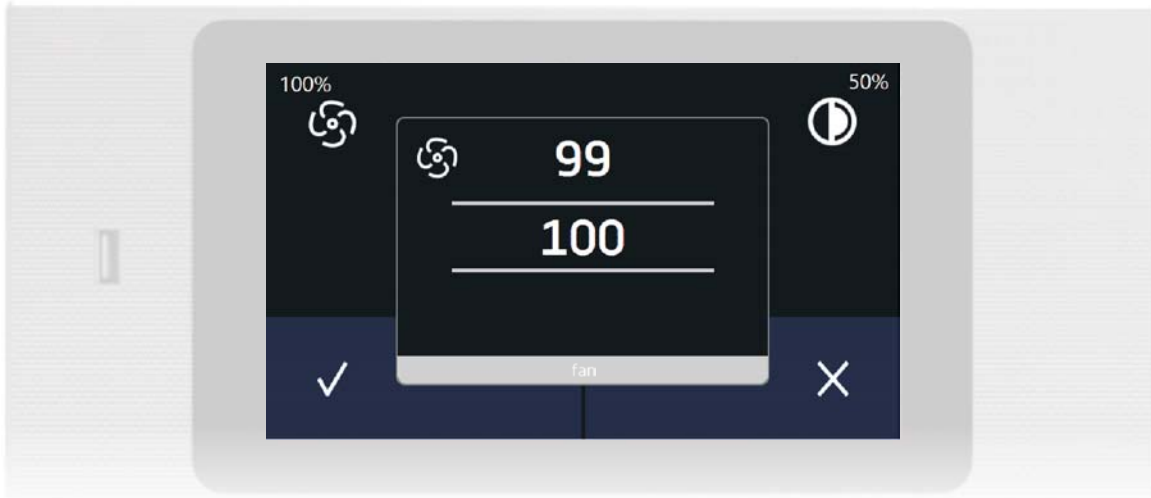

Temperature - you can change temperature settings.

The temperature cannot be lower than under temperature protection +2°C and higher than over temperature protection -2°C.



Fan - allows to control the fan speed between 0% to 100% (according to chamber type).



Air flap - allows you to control the opening of the air flap between 0% to 100% (according to chamber type).



Time - you can change program/segment time by scrolling the number of days, hours and minutes. Time can be set from 1 minute to 365 days, 23 hours and 59 minutes.

There is also a possibility to display time in two ways:

- elapsed time of the program/segment
- remaining time of the program/segment.



You can also set continuous operation by pressing the icon of infinity.

■ Touch screen unlocking

To avoid accidental program switch off or change of the settings, e.g. when cleaning the screen, a screen lock function has been introduced.

If you touch a locked display a panel with circles will pop up.

You need to swipe a blue circle into the white one in order to unlock the screen.



Alarm bar and e-mail notifications

When an alarm goes off, you can hear a beeping sound. The display frame and alarm bar flash red.



Alarm codes

- Door alerts – door ajar alarms
- Critical alerts – critical alarms (eg. sensors malfunction)
- Temperature alerts – under / over temperature alarms
- Humidity alerts – under / over humidity alarms (KK/KKS)

E-mail notifications

Smart PRO controller was equipped with an E-mail notification function. The user with Super Admin permissions can set and activate e-mail notification reports for up to 3 e-mail addresses.

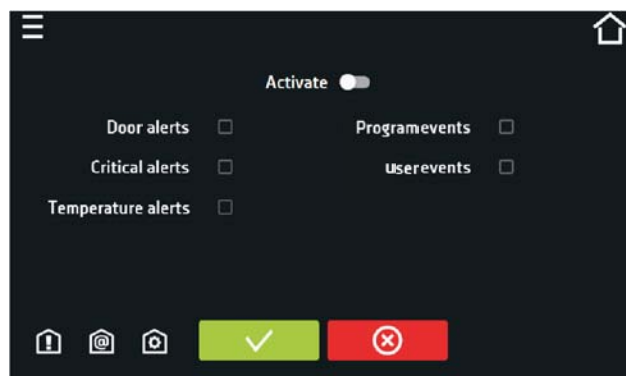

- Door alerts – door ajar alarms
- Critical alerts – critical alarms (eg. sensors malfunction)
- Temperature alerts – under / over temperature alarms
- Program events – information on programs (eg. adding, edition, deletion of a program)
- User events – information on user edition settings (adding, edition, deletion of a user)

Smart4lab.eu – error codes report

Various types of alarms and warnings may appear during the chamber operation. The Smart and Smart PRO controllers display the type of the alarm / malfunction. You can see the QR error code when click on “details”. Now with your smartphone, you can easily go to our website <https://smart4lab.eu> and check what the code refers to and what you need to do to deal with an unexpected alarm, malfunction or error.



Smart graph

The Smart PRO controller allows to generate graphs from the records in the data register. For units equipped with two sensors (eg. climatic chambers with temperature and humidity sensor) you are able to see both graphs at the same time. To display one graph only tap twice on the one you wish to see in detail.

To enlarge a fragment of the graph press anywhere on the graph and swipe both right and down at the same time. By swiping left you can return to the normal size of the graph.



Icon based controller

We created over 150 types of icons to make your work more comfortable and easy. It also makes the Smart & Smart PRO controllers entirely intuitive.

Information panel icons



Operating icon is only visible when: chamber is heating, cooling or defrosting function is on.



Internal light is switched: ON / OFF



Rotating icon shows that the fan is running when program is active. Icon is stopped when the program is off or when the fan is defect (only ILP).



Closed door, open door. The number above the icon presents open door counter, press the icon to cancel the counter. The counter is also cancelled by turning off the unit.



Activated schedule or start delay. The program will start at the set date/time.



Activated schedule – the program will stop at the set date/time.



Ramp status: Chamber is currently cooling down or heating up to reach set temperature.



Set temperature is reached.

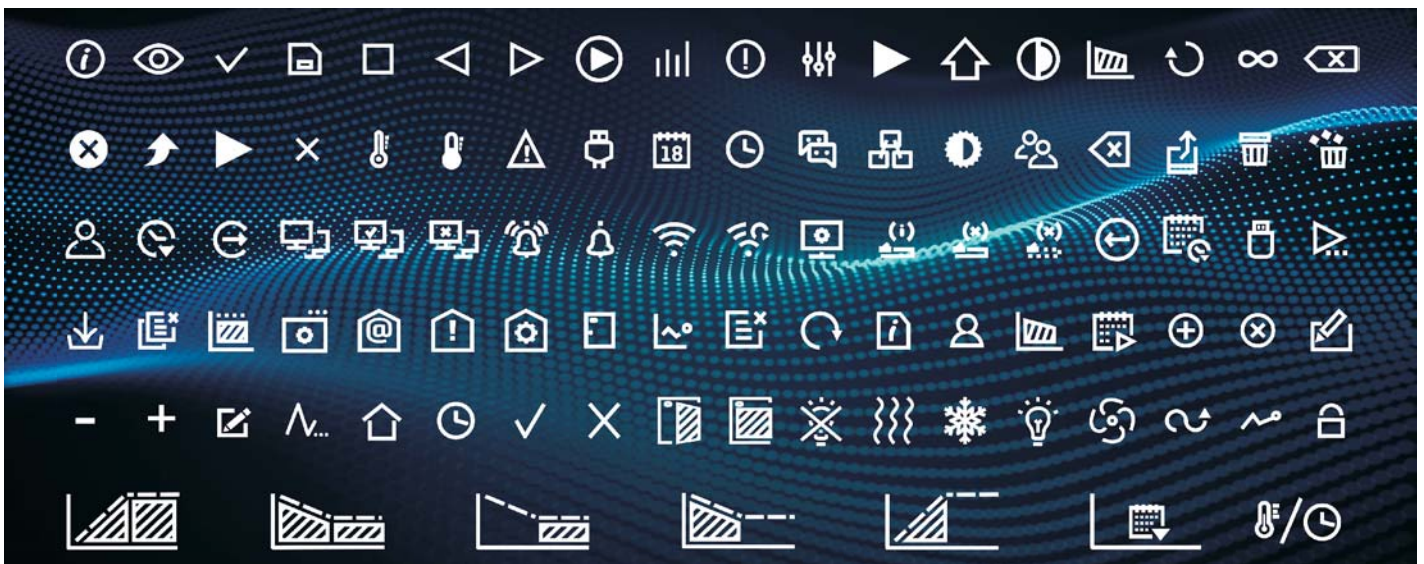

Smart - Smart PRO simplified version

In the 3rd quarter of 2019 we launched the Smart controller which is a direct successor of the BASIC and STD (standard) controllers, currently found in the ST cooled incubators, CHL laboratory refrigerators, ZL laboratory freezers, ZLN-UT ultra-low freezers, as well as the IL cooled incubators, CL laboratory incubators, SL drying ovens and SR laboratory sterilizers.

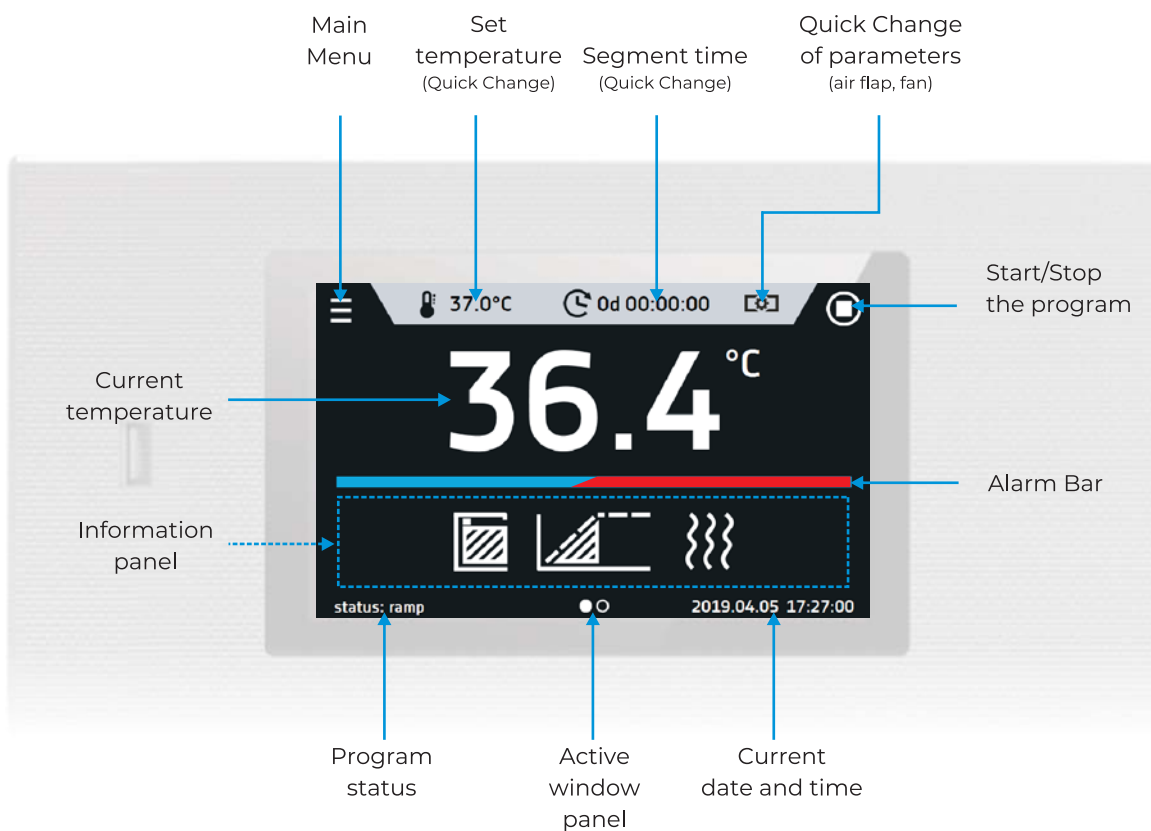

Advantages of the Smart controller

- 4,3", clear, full colour touch screen
- USB and LAN ports for data download
- multi-segment time and temperature programs
- internal memory for programs and data storage
- operating with gloves on
- event registry
- visual and audible alarm
- instruction manual for direct download
- Quick Change of program parameters: temperature, time, fan, air flap (according to model)
- Alarm Bar - instant visual information about chamber status



Touch screens of the Smart and Smart PRO controllers can be operated with latex gloves!

Smart vs. Smart PRO comparison

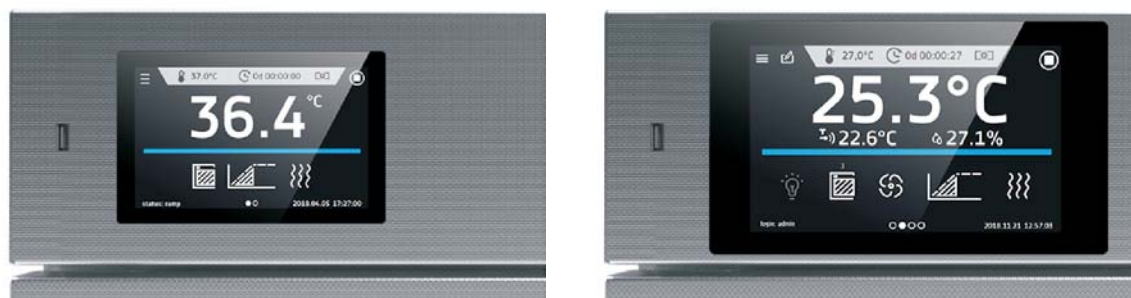

Controller	Smart	Smart PRO
Display	4.3" + touch screen	7" + touch screen
Network	LAN	LAN and Wi-Fi
USB	YES saving registration data saving events	YES saving registration data saving events uploading programs
Keypad	Numeric	Alphanumeric
Languages	PL, EN, RU, CZ, IT, PT, UA, FR, ES	PL, EN, RU, CZ, IT, PT, UA, FR, ES
Main Screen	Dashboard (all relevant data visible from one main window)	Dashboard (all relevant data visible from one main window)
Users	-	5
Users account types	-	User / Admin / Super Admin
Programs	5	40
Program name	Free number assigned	Any
Priority	Parameters	Parameters, time
Segments	6	100
Light control	Only ON/OFF (FOT)	YES (FIT)
Schedule	-	10 schedules
Data registry	max. 10,000 measurement data stored for a maximum of 6 months	max. 10,000 measurement data stored for a maximum of 12 months
Events registry	YES	YES
Statistics	YES - only the current cycle	YES - from every segment and program cycle
Temp. protection class	1.0 or 2.0 (3.1, 3.2, 3.3 - option)	3.1 or 3.2 or 3.3
Quick Note	-	Ability to enter user text notes
Graph	-	YES
Mail notifications	-	Alarm notifications
Unit name	Fixed (serial number)	Editable
Alarm Bar	YES	YES
Quick Change	YES	YES
Software for PC	LabDesk (option)	LabDesk

There is a wide selection of models depending on capacity, basic or more advanced controllers and material of construction.

ST/CHL/ZL/CALDERA model characteristics

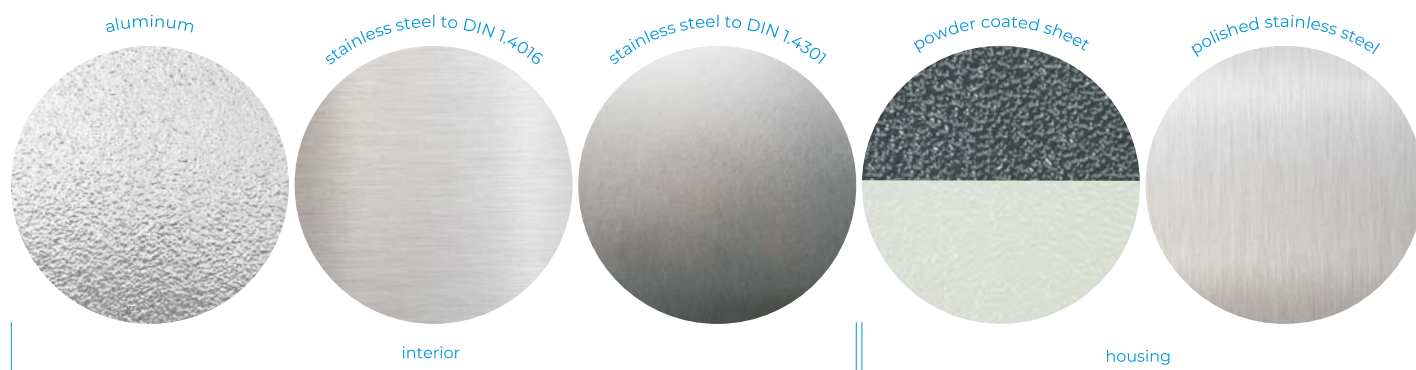

Refrigerators and ST cooled incubators CHL/ST 500, 700, 1200, 1450 (except models with FIT/FOT option) are equipped with a new cooling system M- monoblock. It provides more space in the upper part of the chamber and eliminates condensate tray on the unit's back. Automatic defrosting function is supplied in standard. They are "no frost" units. Letter "M" appears in the model name eg. ST 500 BM SMART (B-basic, M-monoblock).

	interior	housing	temperature protection	controller
B (basic) Smart	aluminum	powder coated sheet	class 1.0	Smart
C (comfort) Smart	stainless steel to DIN 1.4016	powder coated sheet	class 1.0	Smart
CS (comfort/S) Smart	stainless steel to DIN 1.4016	polished stainless steel	class 1.0	Smart
P (premium) Smart	stainless steel to DIN 1.4301	powder coated sheet	class 2.0	Smart
PS (premium/S) Smart	stainless steel to DIN 1.4301	polished stainless steel	class 2.0	Smart
P (premium) Smart PRO	stainless steel to DIN 1.4301	powder coated sheet	class 3.2 / 3.3*	Smart PRO
PS (premium/S) Smart PRO	stainless steel to DIN 1.4301	polished stainless steel	class 3.2 / 3.3*	Smart PRO
CALDERA	stainless steel to DIN 1.4301	polished stainless steel	class 3.1	CALDERA

* depending on the model

CL/IL/SL/SIMPLE/SR/KK model characteristics

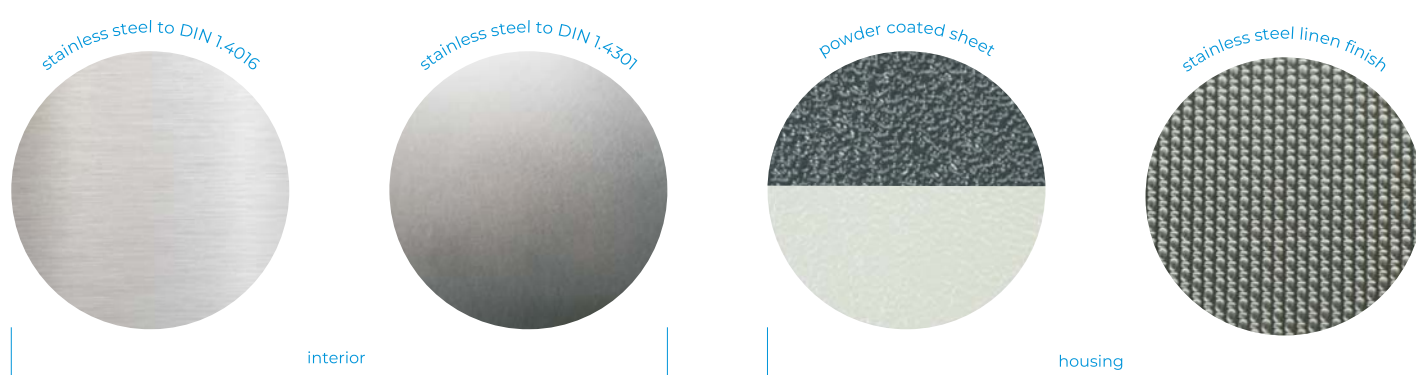

	interior	housing	temperature protection	controller
Smart	stainless steel to DIN 1.4301	powder coated sheet	class 2.0	Smart
IG* Smart	stainless steel to DIN 1.4301	stainless steel linen finish	class 2.0	Smart
Smart PRO	stainless steel to DIN 1.4301	powder coated sheet	class 3.1 / 3.3**	Smart PRO
IG* Smart PRO	stainless steel to DIN 1.4301	stainless steel linen finish	class 3.1 / 3.3**	Smart PRO
SIMPLE	stainless steel to DIN 1.4016	powder coated sheet	class 1.0	SIMPLE

* INOX/G symbol has been replaced by the IG symbol, stainless steel linen finish housing

** depending on the model



COOLING EQUIPMENT

Laboratory refrigerators are equipped with a cooling system and can provide a stable temperature between 0°C ... +15°C



Laboratory refrigerator CHL 2 P Smart PRO



All thermostatic equipment manufactured by POL-EKO can be provided with Calibration Certificate issued by accredited Measurement Laboratory. Detailed information on accreditation is available on website: www.pol-eko.eu.

We have been always reaching our goals by designing and implementing innovative technical solutions. Our designers, supported by the R&D unit, combine cutting-edge technology with creativity to deliver state-of-the-art equipment. Customized solutions and out-of-the-box projects that we willingly carry out are a great endeavour and inspire us for further development.



STANDARD FEATURES

- temperature range 0...+15°C
- quality control protocol (at +4°C)
- English instruction manual
- temperature protection class 1.0 (Smart) and 3.2 (Smart PRO) to DIN 12880
- open door alarm
- castors in standard for models CHL 1200 and 1450
- LAN and USB ports
- internal LED light
- access port (Ø30 mm) on the left wall
- door lock
- wire shelves in B (basic) models, stainless steel wire shelves (INOX) in C (comfort) and P (premium) models
- solid door
- anchoring kit for CHL 500, 700, 1200, 1450 and double/triple chambers

EXTRA FOR SMART PRO

- Wi-Fi
- LAN cable
- LabDesk

AVAILABLE VERSIONS

- Smart
- Smart PRO
- TR tropic (on request) for higher ambient temperatures
- double/triple chamber
- combined with ZLN 85 or ST

SOFTWARE

- LabDesk for data download to a PC via LAN or Wi-Fi (optional for Smart version)

Application

- storage of water and sewage samples, piezometer leachate
- storage of AAS, GC or HPLC calibration standards
- storage of reagents
- storage of medicines and vaccines



		CHL 1	CHL 2	CHL 3	CHL 4	CHL 5	CHL 6	CHL 500	CHL 700	CHL 1200	CHL 1450
Parameter											
air convection		forced									
chamber capacity [l]		70	150	200	250	300	400	500	625	1365	1540
working capacity [l]		55	122	163	203	243	324	469	611	1355	1525
door type		solid / glass or double ¹ (option)									
temperature range [°C]		0...+15									
temperature resolution [°C]		every 0,1									
controller		microprocessor PID, 4,3" (Smart) / 7" (Smart PRO) full colour touch screen									
interior	B (basic)	aluminum									
	C (comfort)	stainless steel to DIN 1.4016									
	C S (comfort/S)	stainless steel to DIN 1.4016									
	P (premium)	acid-proof stainless steel to DIN 1.4301									
	PS (premium/S)	acid-proof stainless steel to DIN 1.4301									
housing	B (basic)	powder coated sheet									
	C (comfort)	powder coated sheet									
	CS (comfort/S)	polished stainless steel									
	P (premium)	powder coated sheet									
	PS (premium/S)	polished stainless steel									
overall dims ² [mm]	A width	550	600	600	600	600	600	640	730	1460	1440
	B height	660	900	1100	1300	1500	1900	1990	1990	1990	1940
	C depth	680	650	650	650	650	650	880	960	960	1060
internal dims ³ [mm]	D width	430	480	480	480	480	480	480	540	1270	1270
	D' width	470	520	520	520	520	520	510	600	1340	1340
	E height	430	660	860	1060	1260	1660	1510	1510	1510	1460
	F depth	300	420	420	420	420	420	610	680	680	780
	F' depth	360	480	480	480	480	480	-	-	-	-
	G depth	-	320	320	320	320	320	-	-	-	-
	H height	-	440	640	840	1040	1440	-	-	-	-
max shelf workload ⁴ [kg]	-	10	10	10	10	10	10	20	30	30	30
	PW ⁵ version	on request						100	100	100	100
max unit workload [kg]	-	20	30	40	50	60	60	100	150	300	300
	W ⁶ version	on request									
nominal power [W]		250	250	250	250	350	350	650	650	650	950
weight ⁷ [kg]		37	54	61	69	75	90	105	121	185	200
temperature fluctuation* at +4°C [±/°C]		0,4	0,4	0,4	0,4	0,4	0,6	0,6	0,8	1,0	1,0
temperature variation* at +4°C [±/°C]		0,7	0,7	0,7	0,8	0,9	0,9	1,0	1,0	1,2	1,2
temperature protection		class 1.0 to DIN 12880 / class 3.2 (option) / class 3.2 in Smart PRO									
power supply**		230V 50-60Hz									
shelves fitted/max		2/2	3/4	3/4	4/6	4/7	4/10	3/11	3/11	2 x 3/11 ⁸	2 x 3/11 ⁸
refrigerant		R1234ze / GWP=1						R290 / GWP=3			
warranty		24 months									
manufacturer		POL-EKO									

all the above technical data refer to standard units (without optional accessories)

* - fluctuation measured in centre of chamber; in space, variation (K) calculated for chamber as: $K = \frac{T_{avg\ max} - T_{avg\ min}}{2}$

** - other power supplies on request

1 - additional internal glass door

2 - depth doesn't include 50 mm of power cable, the width does not include the 20 mm of rubber plug

3 - dims of units with double door are smaller

4 - on uniformly loaded surface

5 - reinforced shelf



6 - reinforced version

7 - for units with solid door, in version B (basic)

8 - two columns with 3 shelves each

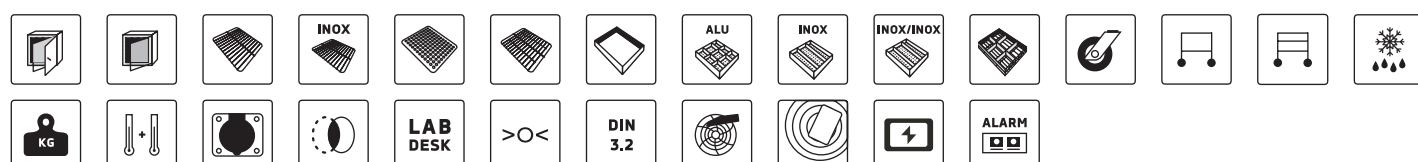
Options and accessories (icon description see pages 80-86)

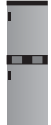

		CHL 1/1	CHL 1/1/1	CHL 2/2	CHL 2/3
Parameter					
air convection		forced			
chamber capacity [l]		70 / 70	70 / 70 / 70	150 / 150	150 / 200
working capacity [l]		55 / 55	55 / 55 / 55	122 / 122	122 / 163
door type		solid / glass or double ¹ (option)			
temperature range [°C]		0...+15			
temperature resolution [°C]		every 0,1			
controller		microprocessor PID, 4,3" (Smart) / 7" (Smart PRO) full colour touch screen			
interior	B (basic)	aluminum			
	C (comfort)	stainless steel to DIN 1.4016			
	C S (comfort/S)	stainless steel to DIN 1.4016			
	P (premium)	acid-proof stainless steel to DIN 1.4301			
	P S (premium/S)	acid-proof stainless steel to DIN 1.4301			
housing	B (basic)	powder coated sheet			
	C (comfort)	powder coated sheet			
	C S (comfort/S)	polished stainless steel			
	P (premium)	powder coated sheet			
	P S (premium/S)	polished stainless steel			
overall dims ² [mm]	A width	550	550	600	600
	B height	1290	1920	1720	1910
	C depth	680	680	650	650
internal dims ³ [mm]	D width	430	430	480	480
	D' width	470	470	520	520
	E height	430	430	660	660 / 860
	F depth	300	300	420	420
	F' depth	360	360	480	480
	G depth	-	-	320	320
	H height	-	-	440	440 / 640
	max shelf workload ⁴ [kg]	-	10	10	10
	PW ⁵ version	on request			
max unit workload [kg]	-	20 / 20	20 / 20 / 20	30 / 30	30 / 40
	W ⁶ version	on request			
nominal power [W]		500	750	500	500
weight ⁷ [kg]		65	98	109	114
temperature fluctuation* at +4°C [± °C]		0,4	0,4	0,4	0,4
temperature variation* at +4°C [± °C]		0,7	0,7	0,7	0,7
temperature protection		class 1.0 to DIN 12880 / class 3.2 (option) / class 3.2 in Smart PRO			
power supply**		230V 50-60Hz			
shelves fitted/max		see page 22			
refrigerant		R1234ze / GWP=1			
warranty		24 months			
manufacturer		POL-EKO			

all the above technical data refer to standard units (without optional accessories)

* - fluctuation measured in centre of chamber; in space, variation (K) calculated for chamber as: $K = \pm (T_{avg\ max} - T_{avg\ min}) / 2$

** - other power supplies on request

1 - additional internal glass door

2 - depth doesn't include 50 mm of power cable, the width does not include the 20 mm of rubber plug

3 - dims of units with double door are smaller

4 - on uniformly loaded surface

5 - reinforced shelf

6 - reinforced version

7 - for units with solid door, in version B (basic)

Options and accessories (icon description see pages 80-86)

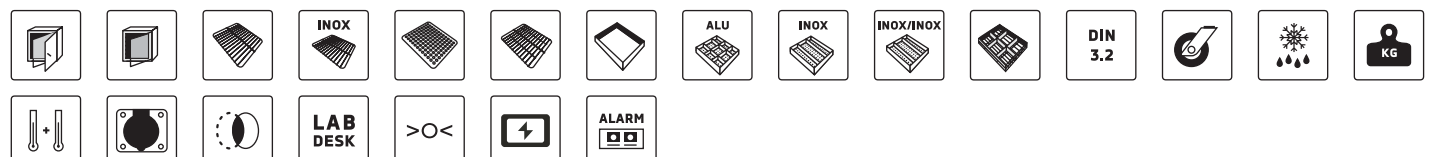

■ Dimensions CHL 1

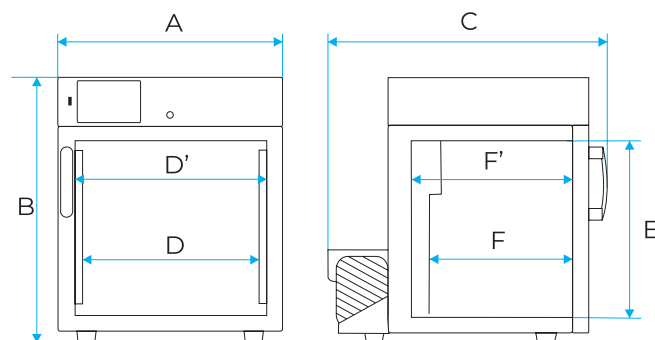

■ Dimensions CHL 2/3/4/5/6

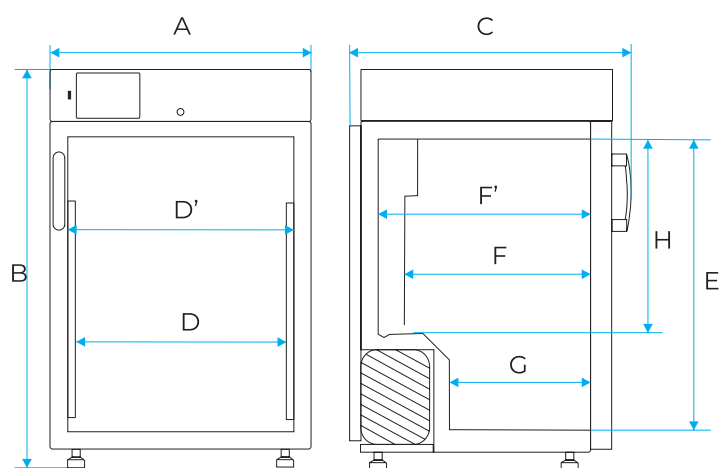

■ Dimensions CHL 500/700/1200/1450

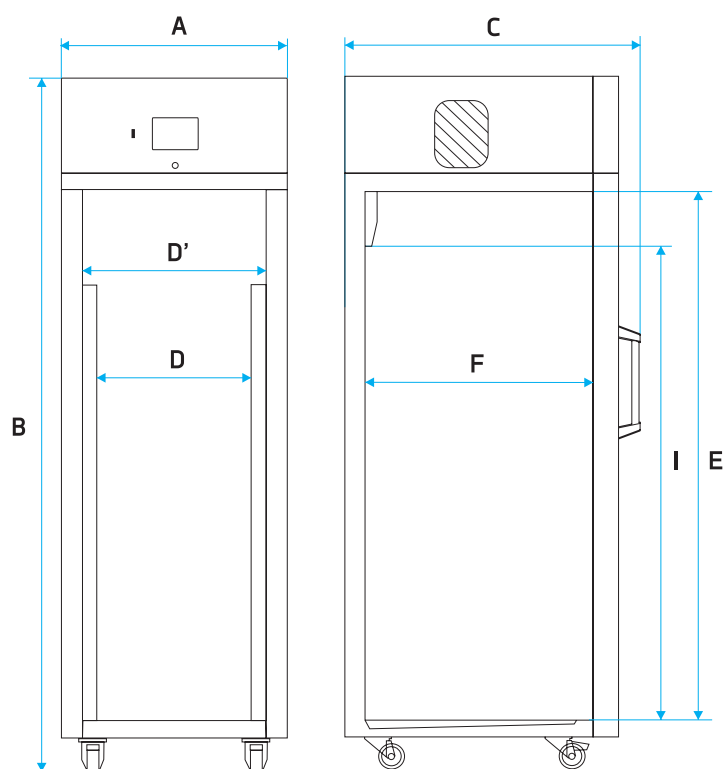

Laboratory freezers can freeze and store frozen samples

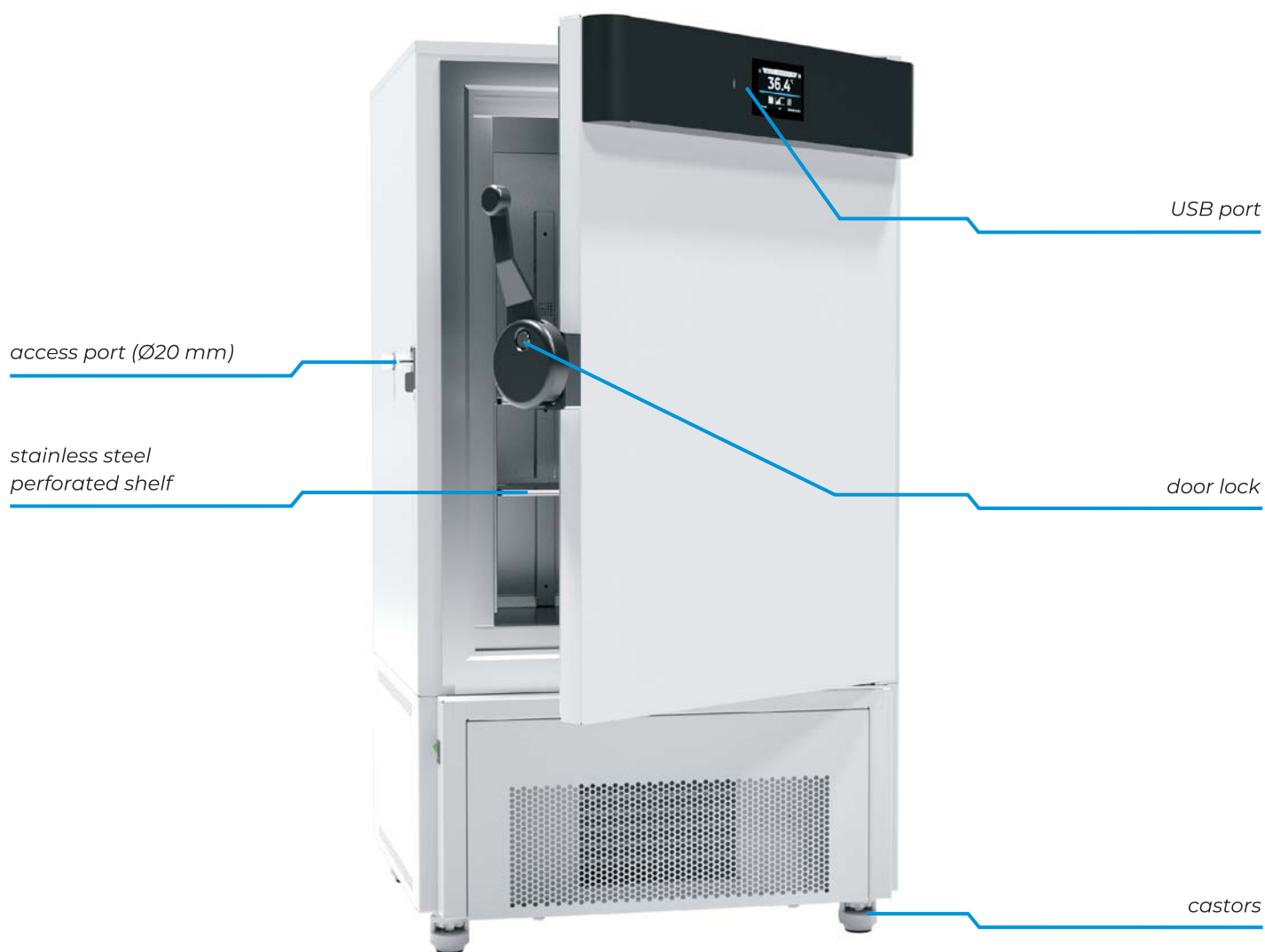

Laboratory freezer ZLN-T 200 C Smart



All thermostatic equipment manufactured by POL-EKO can be provided with Calibration Certificate issued by accredited Measurement Laboratory. Detailed information on accreditation is available on website: www.pol-eko.eu.

Advanced control systems and electronics are indispensable for achieving success, there's no doubt about it. Nowadays, no one can imagine working in a laboratory without technology. New solutions emerge in the market every day, so staying up to date with them is a big challenge for our team. We implement the latest hi-tech solutions to provide our customers with great product experience.



STANDARD FEATURES

- temperature range -25...0°C for ZLN 85 and -40...0°C for ZL-T 125, 200, 300
- quality control protocol (at -20°C)
- English instruction manual
- open door alarm
- castors in standard (except ZLN 85)
- LAN and USB ports
- access port (Ø20 mm) on the left wall
- door lock
- stainless steel wire shelves (INOX) for ZLN 85
- stainless steel shelves with hole for ZLN-T 125, 200, 300 and perforated for ZLW-T 200, 300
- solid door

EXTRA FOR SMART PRO

- Wi-Fi
- LAN cable
- LabDesk

AVAILABLE VERSIONS

- Smart
- Smart PRO
- with natural air convection
- with forced air convection
- reinforced







SOFTWARE

- LabDesk for data download to a PC via LAN or Wi-Fi (optional for Smart version)

Application

- long-term storage of samples and biological material for research
- storage of easily decomposing material (e.g. solid state)
- freeze resistance tests (e.g. of building materials: concrete, wood etc.)
- pre-freezing
- plasma storage



		ZLN 85	ZLN-T 125	ZLN-T 200	ZLN-T 300	ZLW-T 200	ZLW-T 300
Parameter							
air convection		natural				forced	
chamber capacity [l]		85	130	210	310	210	310
working capacity [l]		73	109	180	262	140	213
door type		solid					
temperature range [°C]		-25...0	-40...0				
temperature resolution [°C]		every 0,1					
controller		microprocessor PID, 4,3" (Smart) / 7" (Smart PRO) full colour touch screen					
interior	C (comfort)	stainless steel to DIN 1.4016					
	CS (comfort/S)	stainless steel to DIN 1.4016					
	P (premium)	acid-proof stainless steel to DIN 1.4301					
	PS (premium/S)	acid-proof stainless steel to DIN 1.4301					
housing	C (comfort)	powder coated sheet					
	CS (comfort/S)	polished stainless steel					
	P (premium)	powder coated sheet					
	PS (premium/S)	polished stainless steel					
overall dims ¹ [mm]	A width	620	720	820	820	820	820
	B height	930	1190	1380	1730	1380	1730
	C depth	650	810	810	810	810	810
internal dims [mm]	D width	380	370	450	450	450	450
	D' width	420	420	520	520	520	520
	E height	590	600	770	1120	770	1120
	F depth	400	520	520	520	520	520
	F' depth	440	530	530	530	530	530
	G depth	230	-	-	-	-	-
	H height	380	-	-	-	550	900
max shelf workload ² [kg]	-	10	10	10	10	10	10
	PW ³ version	-	50	50	50	50	50
max unit workload [kg]	-	30	50	65	80	65	80
	W ⁴ version	-	100	130	160	160	160
nominal power [W]		200	450	450	450	450	450
weight [kg]		62	105	120	185	120	185
temperature fluctuation* at -20°C [± °C]		0,5	0,5	0,5	0,5	1,5	1,5
temperature variation* at -20°C [± °C]		2,0	2,0	2,5	2,5	1,8	1,8
temperature protection		class 3.2 to DIN 12880 (option)					
power supply**		230V 50-60Hz					
shelves fitted/max		2/4	2/3	2/4	3/6	2/4	3/6
refrigerant		R455A / GWP=146			R290 / GWP=3		
warranty		24 months					
manufacturer		POL-EKO					

all the above technical data refer to standard units (without optional accessories)

* - fluctuation measured in centre of chamber; in space, variation (K) calculated for chamber as: $K = \frac{T_{avg\ max} - T_{avg\ min}}{2}$

** - other power supplies on request

1 - depth doesn't include 50 mm of power cable

2 - on uniformly loaded surface

3 - reinforced shelf

4 - reinforced version

Options and accessories (icon description see pages 80-86)



■ Dimensions ZLN 85

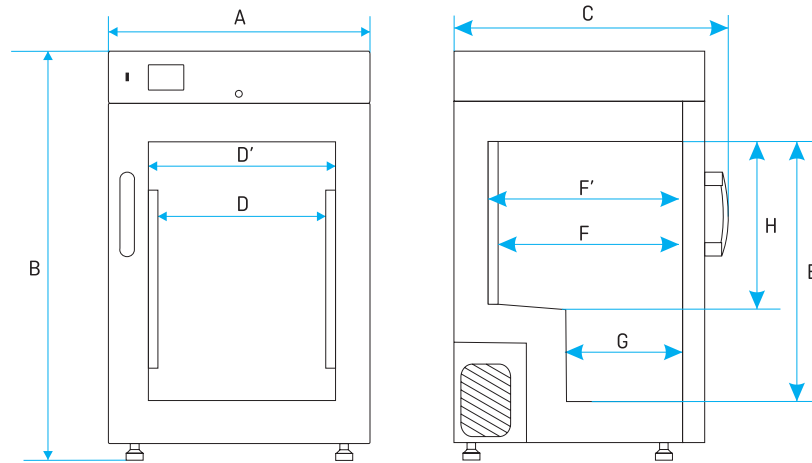

■ Dimensions ZLW-T 200/300

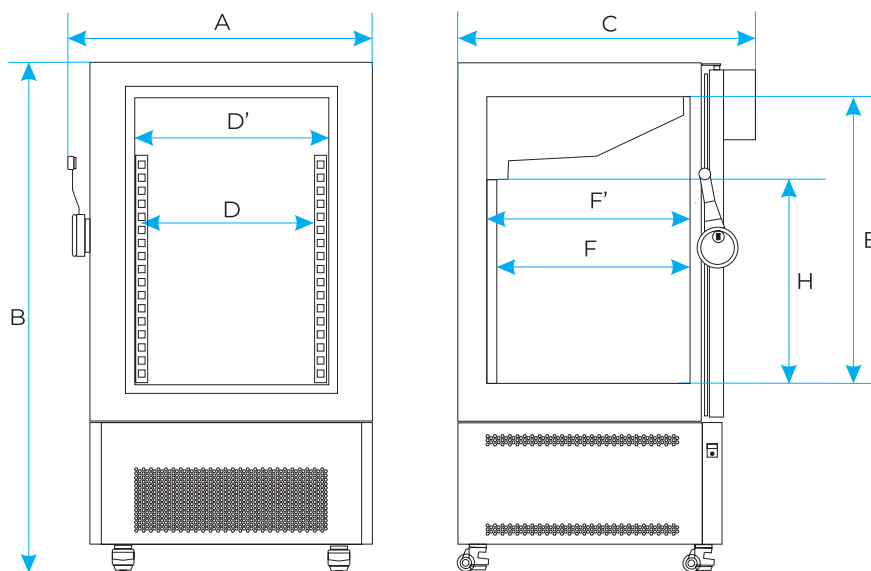

■ Dimensions ZLN-T 125/200/300

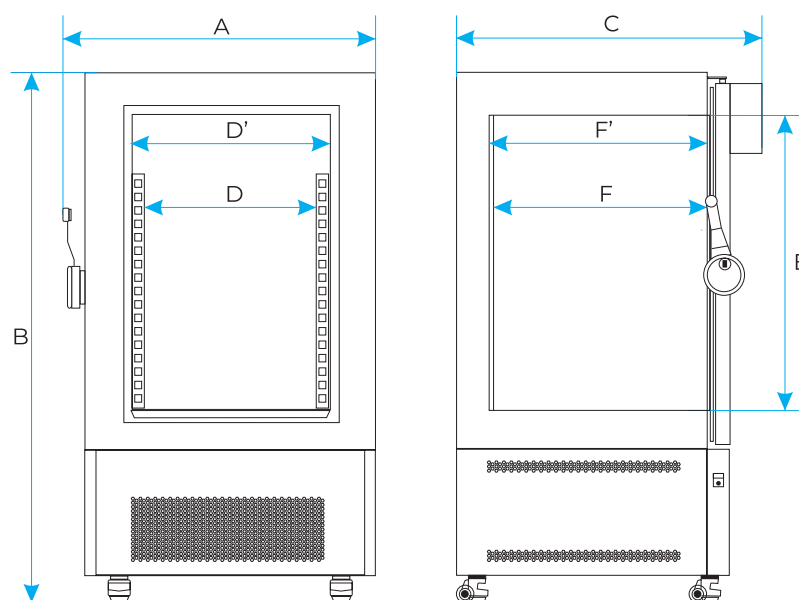

Ultra-low freezers are used for deep freezing of biotechnological samples and other materials which should be stored at very low temperatures



Ultra-low freezer ZLN-UT 300 VIP C Smart



All thermostatic equipment manufactured by POL-EKO can be provided with Calibration Certificate issued by accredited Measurement Laboratory. Detailed information on accreditation is available on website: www.pol-eko.eu.

Options for ultra-low freezers



ZLN-UT/ST rack with drawers

sturdy and heavy duty, made of stainless steel; feature quick and easy access to all boxes; 3 or 4 drawers (each for 4 boxes) per rack.



CO₂ back up system

enables the freezer controller to dose CO₂ in case of undesired temperature increase in the chamber. It is supplied with an internal battery. This solution is particularly recommended in the event of a power outage.



Boxes

made of polypropylene (dimensions 133x133x50mm; each box suits 81 test-tubes of Ø 12,5mm) or made of cardboard.

model	compartments	racks per compartment (option)	boxes per rack (option)	rack set (option)	boxes per compartment (option)	boxes per unit (option)	test-tubes per unit* (option)
ZLN-UT 130	1	8	12	8 x ZLN-UT/ST12	96	96	7 776
ZLN-UT 200	2	8	12	16 x ZLN-UT/ST12	96	192	15 552
ZLN-UT 300	2	8	16	16 x ZLN-UT/ST16	128	256	20 736
ZLN-UT 500	2	4+8	12/16	8 x ZLN-UT/ST12 + 16 x ZLN-UT/ST16	176	352	28 512





* applies to 12,5 mm diameter test-tubes

ZLN-UT 130 VIP

ZLN-UT 200 VIP

ZLN-UT 300 VIP

ZLN-UT 500 VIP

Parameter					
air convection		natural			
chamber capacity [l]		130	259	345	482
number of boxes 133x133x50mm [pcs]		96	192	256	352
door type		double, solid			
temperature range [°C]		-86...-50			
temperature resolution [°C]		every 0,1			
cooling down time from +22°C to -80°C [min]		120	160	180	210
heating time in case of power failure from -80°C to -60°C [min]		40	50	90	90
controller		microprocessor PID, 4,3" (Smart) / 7" (Smart PRO) full colour touch screen			
interior	C (comfort)	stainless steel to DIN 1.4016			
	P (premium)	acid-proof stainless steel to DIN 1.4301			
housing	C (comfort)	powder coated sheet			
	P (premium)	powder coated sheet			
overall dims ¹ [mm]	A width	880	880	880	880
	B height	940	1390	1620	2000
	C depth	960	960	960	960
internal dims [mm]	D width	620	620	620	620
	E height	360	770	1000	1380
	F depth	580	580	580	580
	G height	-	360	480	670
max unit workload [kg]		45	65	65	85
max shelf workload [kg]		10	10	10	10
nominal power [W]		2100	2100	2100	2100
energy consumption 24h [kWh] at -80°C		11	15	15	17
weight [kg]		147	200	220	243
temperature fluctuation* at -80°C [±/°C]		1,6	1,5	1,4	1,4
temperature variation* at -80°C [±/°C]		1,6	4,0	3,0	3,5
power supply**		230V 50-60Hz			
shelves fitted/max		1/1	2/2	2/2	4 / 4
number of internal chambers		1	2	2	2
refrigerant		R290 / GWP=3 R170 / GWP=6			
warranty		24 months			
manufacturer		POL-EKO			

all the above technical data refer to standard units (without optional accessories)

* - fluctuation measured in centre of chamber; in space, variation (K) calculated for chamber as: $K = \frac{T_{avg\ max} - T_{avg\ min}}{2}$

** - other power supplies on request

1 - depth doesn't include 50 mm of power cable

Options and accessories (icon description see pages 80-86)



Application

- biotechnology
- pharmacy
- storage

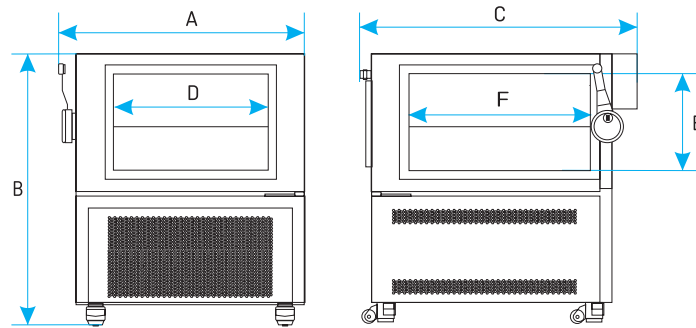
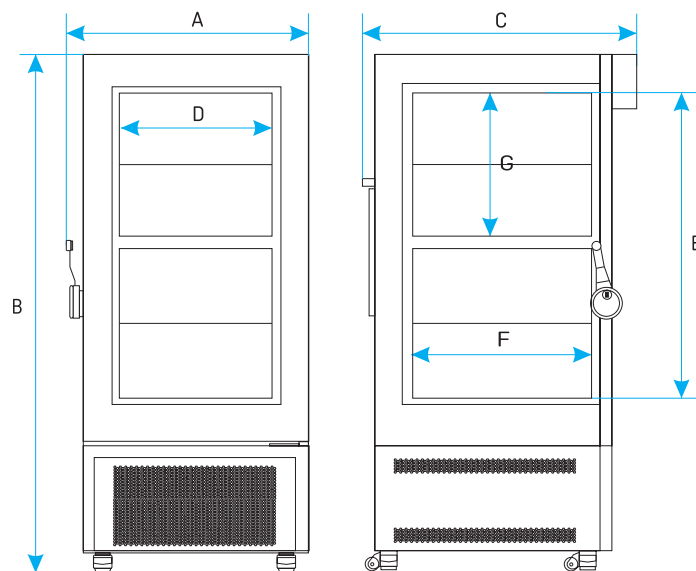
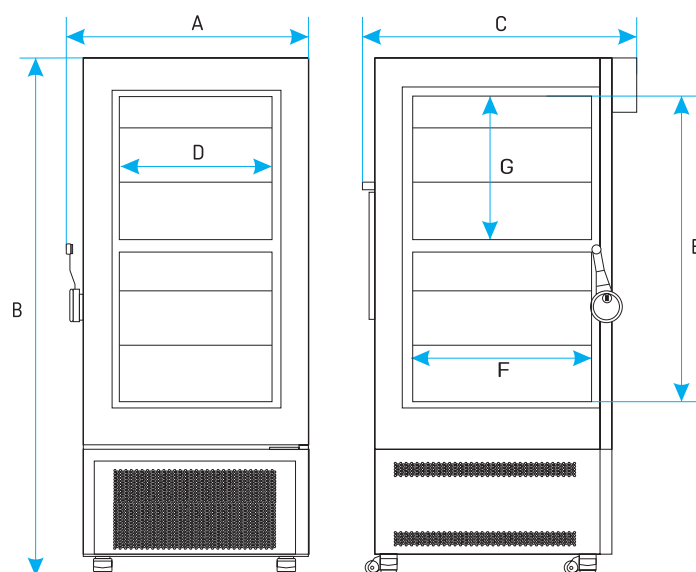

■ Dimensions ZLN-UT 130 VIP**■ Dimensions ZLN-UT 200/ 300 VIP****■ Dimensions ZLN-UT 500 VIP**



HEATING AND COOLING EQUIPMENT

Cooled incubators (ST) can provide stable temperature between +3...+70°C regardless of ambient conditions



Cooled incubator ST 2 C Smart PRO



All thermostatic equipment manufactured by POL-EKO can be provided with Calibration Certificate issued by accredited Measurement Laboratory. Detailed information on accreditation is available on website: www.pol-eko.eu.

The wide range of our products requires specialisation in many fields. The production of each part involves complex sequence of technological processes, but modern machinery park comes to our aid. To achieve repeatability and highest quality of our components, most of the work is ensured by CNC machines and robots. We put our passion, heart and experience in every detail.



STANDARD FEATURES

- temperature range +3...+40°C (+70°C for Smart PRO)
- quality control protocol (at +37°C)
- English instruction manual
- temperature protection class 1.0 to DIN 12880 for B (basic) and C (comfort) versions, 2.0 for P (premium) version and 3.3 for Smart PRO
- open door alarm
- castors in standard for models ST 1200 and 1450
- LAN and USB ports
- internal LED light
- access port (Ø30 mm) on the left wall
- door lock
- wire shelves in B (basic) models, stainless steel wire shelves (INOX) in C (comfort) and P (premium) models
- solid door
- anchoring kit for ST 500, 700, 1200, 1450 and double/triple chambers

EXTRA FOR SMART PRO

- Wi-Fi
- LAN cable
- LabDesk

AVAILABLE VERSIONS

- Smart
- Smart PRO
- FOT photoperiod (see page 44)
- FIT phytotron (see page 45)
- TR tropic (on request) for higher ambient temperatures
- double/triple chamber
- combined with ZLN 85 or CHL

SOFTWARE

- LabDesk for data download to a PC via LAN or Wi-Fi (optional for Smart version)

Application

- BOD determination
- microbiological research
- plant growing and microorganisms breeding at specified temperature
- storage of liquids and samples for physicochemical analysis

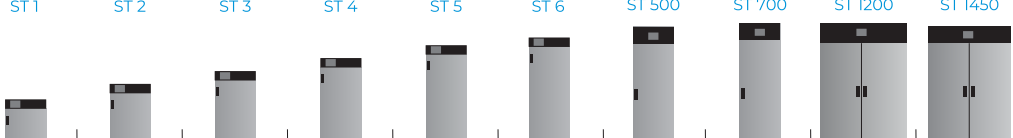

	ST 1	ST 2	ST 3	ST 4	ST 5	ST 6	ST 500	ST 700	ST 1200	ST 1450	
Parameter											
air convection	forced										
chamber capacity [l]	70	150	200	250	300	400	500	625	1365	1540	
working capacity [l]	55	122	163	203	243	324	469	611	1355	1525	
door type	solid / glass or double ¹ (option)										
temperature range [°C]	+3...+40 / up to +70 (option) / +3...+70 in Smart PRO										
temperature resolution [°C]	every 0,1										
controller	microprocessor PID, 4,3" (Smart) / 7" (Smart PRO) full colour touch screen										
interior	B (basic)	aluminum									
	C (comfort)	stainless steel to DIN 1.4016									
	CS (comfort/S)	stainless steel to DIN 1.4016									
	P (premium)	acid-proof stainless steel to DIN 1.4301									
	PS (premium/S)	acid-proof stainless steel to DIN 1.4301									
housing	B (basic)	powder coated sheet									
	C (comfort)	powder coated sheet									
	CS (comfort/S)	polished stainless steel									
	P (premium)	powder coated sheet									
	PS (premium/S)	polished stainless steel									
overall dims [mm]	A width	550	600	600	600	600	600	640	710	1460	1440
	B height	660	900	1100	1300	1500	1900	1990	1990	1990	1940
	C depth	680	650	650	650	650	650	880	960	960	1060
internal dims ³ [mm]	D width	430	480	480	480	480	480	480	540	1270	1270
	D' width	470	520	520	520	520	520	510	600	1330	1340
	E height	430	660	860	1060	1260	1660	1510	1510	1510	1460
	F depth	300	420	420	420	420	420	610	680	680	780
	F' depth	360	480	480	480	480	480	-	-	-	-
	G depth	-	320	320	320	320	320	-	-	-	-
	H height	-	440	640	840	1040	1440	-	-	-	-
max shelf workload ⁴ [kg]	-	10	10	10	10	10	10	20	30	30	30
	PW ⁵ version	on request						100	100	100	100
max unit workload [kg]	-	20	30	40	50	60	60	100	150	300	300
	W ⁶ version	on request									
nominal power [W]	250	250	250	250	350	350	650	650	650	950	
weight ⁷ [kg]	37	54	61	69	75	90	105	121	185	200	
temperature fluctuation* at +37°C [± °C]	0,3	0,3	0,3	0,3	0,3	0,3	0,3	0,3	0,3	0,3	
temperature variation* at +37°C [± °C]	0,5	0,5	0,5	0,6	0,6	0,6	1,0	1,0	1,0	1,0	
temperature protection	class 1.0 to DIN 12880 / class 3.3 (option) / class 2.0 in P version / class 3.3 in Smart PRO										
power supply**	230V 50-60Hz										
shelves fitted/max	2/2	3/4	3/4	4/6	4/7	4/10	3/11	3/11	2 x 3/11 ⁸	2 x 3/11 ⁸	
refrigerant	R1234ze / GWP=1						R290 / GWP=3				
warranty	24 months										
manufacturer	POL-EKO										

all the above technical data refer to standard units (without optional accessories)

* - fluctuation measured in centre of chamber; in space, variation (K) calculated for chamber as: $K = \pm (T_{avg\ max} - T_{avg\ min}) / 2$

** - other power supplies on request

1- additional internal glass door

2- depth does not include 50 mm of power cable, the width does not include the 20 mm of rubber plug

3- dims of units with double door are smaller

4- on uniformly loaded surface

5- reinforced shelf

6- reinforced version

7- for equipment with solid door, in version B (basic)

8- two columns with 3 shelves each

Options and accessories (icon description see pages 80-86)

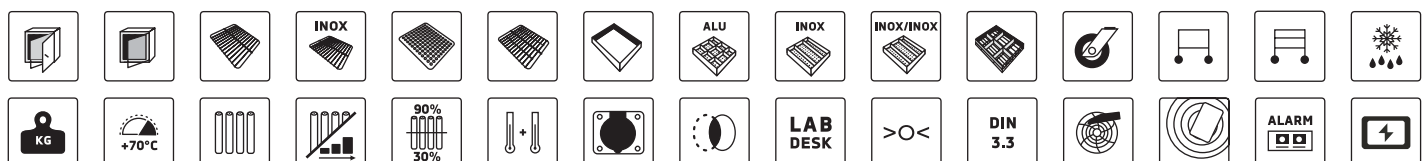



Parameter	ST 1/1	ST 1/1/1	ST 2/2	ST 2/3	
air convection	forced				
chamber capacity [l]	70 / 70	70 / 70 / 70	150 / 150	150 / 200	
working capacity [l]	55 / 55	55 / 55 / 55	122 / 122	122 / 163	
door type	solid / glass or double ¹ (option)				
temperature range [°C]	+3...+40 / up to +70 (option) / +3...+70 in Smart PRO				
temperature resolution [°C]	every 0,1				
controller	microprocessor PID, 4,3" (Smart) / 7" (Smart PRO) full colour touch screen				
interior	B (basic)	aluminum			
	C (comfort)	stainless steel to DIN 1.4016			
	CS (comfort/S)	stainless steel to DIN 1.4016			
	P (premium)	acid-proof stainless steel to DIN 1.4301			
	PS (premium/S)	acid-proof stainless steel to DIN 1.4301			
housing	B (basic)	powder coated sheet			
	C (comfort)	powder coated sheet			
	CS (comfort/S)	polished stainless steel			
	P (premium)	powder coated sheet			
	PS (premium/S)	polished stainless steel			
overall dims ² [mm]	A width	550	550	600	600
	B height	1290	1920	1720	1930
	C depth	680	680	650	650
internal dims ³ [mm]	D width	430	430	480	480
	D' width	470	470	520	520
	E height	430	430	660	660 / 860
	F depth	300	300	420	420
	F' depth	360	360	480	480
	G depth	-	-	320	320
	H height	-	-	440	440 / 640
max shelf workload ⁴ [kg]	-	10	10	10	10
	PW ⁵ version	on request			
max unit workload [kg]	-	20 / 20	20 / 20 / 20	30 / 30	30 / 40
	W ⁶ version	on request			
nominal power [W]	500	750	500	500	
weight ⁷ [kg]	65	98	109	114	
temperature fluctuation* at +37°C [± °C]	0,3	0,3	0,3	0,3	
temperature variation* at +37°C [± °C]	0,5	0,5	0,5	0,5	
temperature protection	class 1.0 to DIN 12880 / class 3.3 (option) / class 2.0 in P version / class 3.3 in Smart PRO				
power supply**	230V 50-60Hz				
shelves fitted/max	see page 36				
refrigerant	R1234ze / GWP=1				
warranty	24 months				
manufacturer	POL-EKO				

all the above technical data refer to standard units (without optional accessories)

* - fluctuation measured in centre of chamber; in space, variation (K) calculated for chamber as: $K = \frac{T_{avg\ max} - T_{avg\ min}}{2}$

** - other power supplies on request

1- additional internal glass door

2- depth does not include 50 mm of power cable, the width does not include the 20 mm of rubber plug

3- dims of units with double door are smaller

4- on uniformly loaded surface

5- reinforced shelf

6- reinforced version

7- for units with solid door, in version B (basic)

Options and accessories (icon description see pages 80-86)

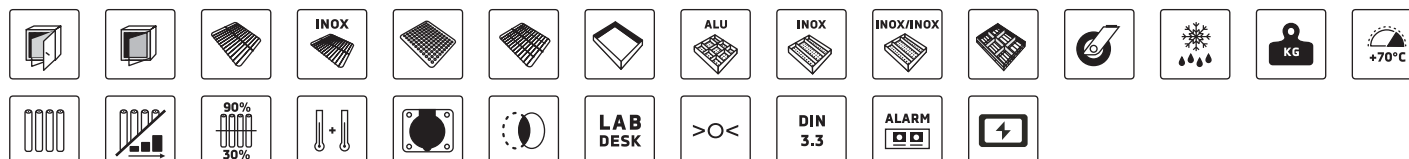

■ Dimensions ST 1

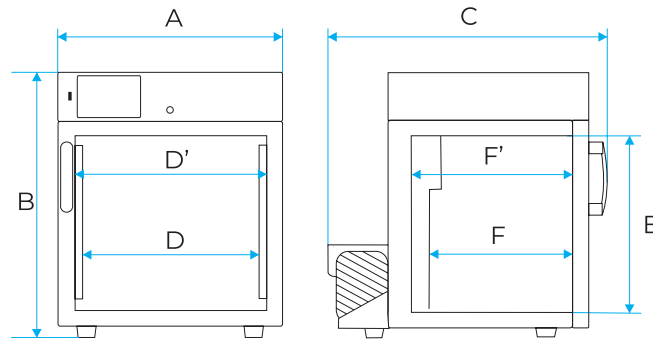

■ Dimensions ST 2/3/4/5/6

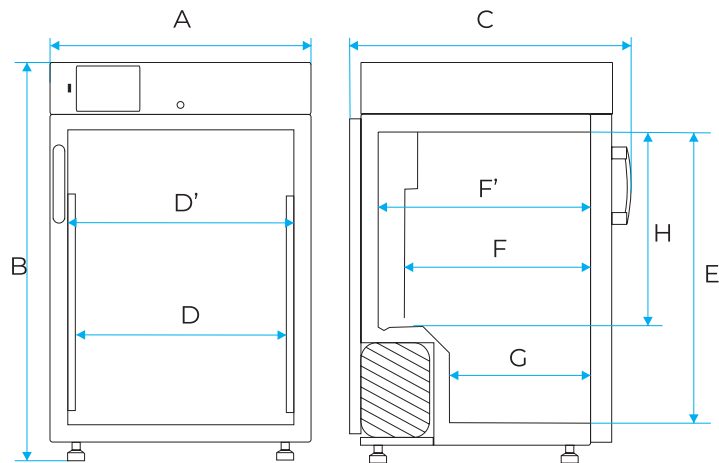

■ Dimensions ST 500/700/1200/1450

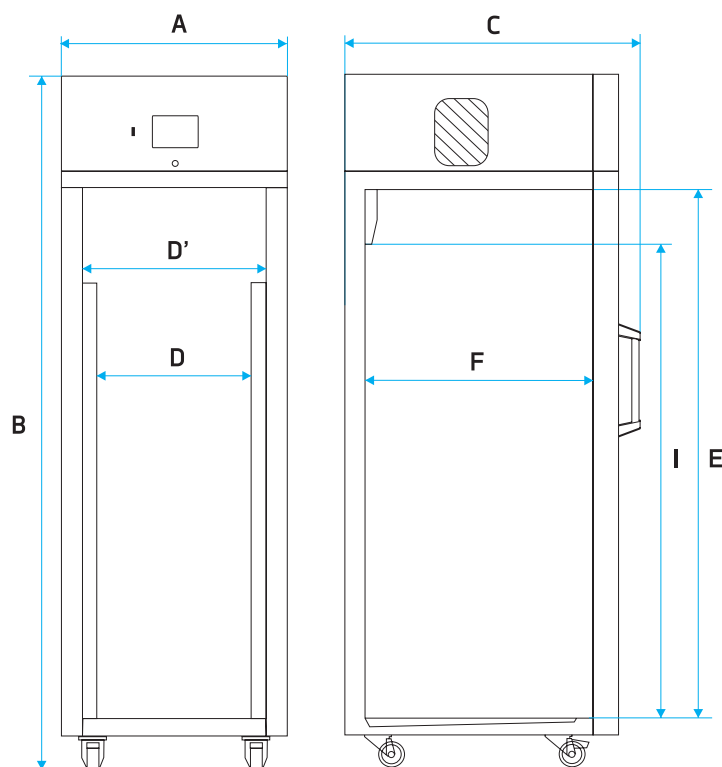

Cooled incubators are perfect for incubation of samples in a stable environment, regardless of ambient conditions, at temperatures from -10 up to +100°C



ILW IG Smart PRO cooled incubator



All thermostatic equipment manufactured by POL-EKO can be provided with Calibration Certificate issued by accredited Measurement Laboratory. Detailed information on accreditation is available on website: www.pol-eko.eu.

Production of thousands of units a year with an individual approach to every single product while guaranteeing the highest standards requires flexibility and rapidity in action. The continuity of supplies of parts and subassemblies to production stations is ensured by the standards we have developed over the years, which are also monitored by the ERP system.



STANDARD FEATURES

- temperature range -10°C (option) / 0°C...+70°C (+100°C in Smart PRO)
- English instruction manual
- temperature protection class 2.0 (Smart) and 3.3 (Smart PRO) to DIN 12880
- open door alarm
- castors in standard for models ILW 240, 400, 750
- LAN and USB ports
- access port (Ø30 mm) on the left wall
- door lock
- stainless steel wire shelves (INOX)
- double door (external solid, internal glass)

EXTRA FOR SMART PRO

- Wi-Fi
- LAN cable
- LabDesk

AVAILABLE VERSIONS

- Smart
- Smart PRO
- FOT photoperiod (see page 44)
- FIT phytotron (see page 45)
- reinforced





SOFTWARE

- LabDesk for data download to a PC via LAN or Wi-Fi (optional for Smart version)

Application

- microbiological tests
- plant growing, microorganisms breeding at precisely controlled environment
- incubation of samples under certain temperature conditions
- incubation of samples for BOD determinations



	ILW 53	ILW 115	ILW 240	ILW 400	ILW 750	
Parameter						
air convection	forced					
chamber capacity [l]	56	112	245	424	749	
door type	double ¹ / door with viewing window (option)					
temperature range [°C]	-10 (option) / 0...+70 (+100 in Smart PRO version)					
temperature resolution [°C]	every 0,1					
controller	microprocessor PID, 4,3" (Smart) / 7" (Smart PRO) full colour touch screen					
interior	acid-proof stainless steel to DIN 1.4301					
housing	-	powder coated sheet				
	IG	stainless steel linen finish				
overall dims ² [mm]	A width	590	660	820	1020	1260
	B height	1000	1140	1430	1730	1910
	C depth	630	720	780	780	890
internal dims [mm]	D width	400	460	600	800	1040
	E height	390	540	800	1040	1200
	F depth	350	450	510	510	600
max shelf workload ⁵ [kg]	-	25	25	25	25	-
	PW ³ version	50	50	100	100	100
max unit workload [kg]	-	40	60	90	120	140
	W ⁴ version	80	120	300	300	300
nominal power [W]	450	500	900	1300	1900	
weight [kg]	69	90	140	185	256	
temperature fluctuation* at +37°C [± °C]	0,2	0,2	0,2	0,2	0,2	
temperature variation* at +37°C [± °C]	0,3	0,3	0,3	0,3	0,3	
temperature protection	class 2.0 to DIN 12880 / class 3.3 (option) / class 3.3 in Smart PRO					
power supply**	230V 50-60Hz					
shelves fitted/max	2/5	2/7	3/10	3/14	5/16	
refrigerant	1234ze / GWP=1		R290 / GWP=3			
warranty	24 months					
manufacturer	POL-EKO					

all the above technical data refer to standard units (without optional accessories)

* - fluctuation measured in centre of chamber; in space, variation (K) calculated for chamber as: $K = \pm (T_{avg\ max} - T_{avg\ min}) / 2$

** - other power supplies on request

1 - internal glass door, external solid

2 - depth doesn't include 50 mm of power cable

3 - reinforced shelf

4 - reinforced version

5 - on uniformly loaded surface

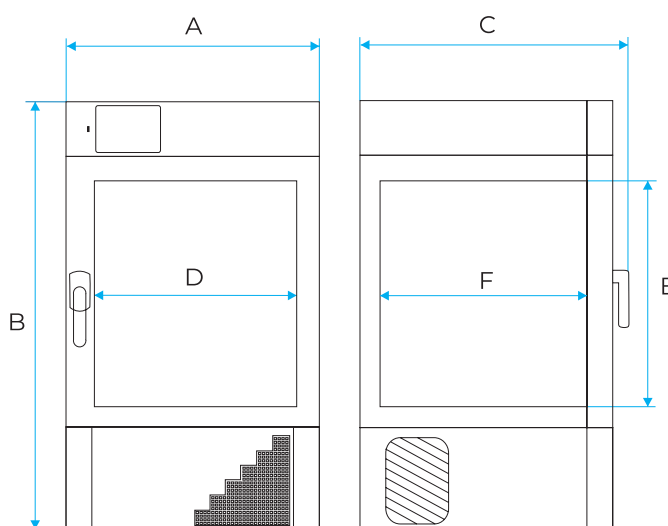

Options and accessories (icon description see pages 80-86)

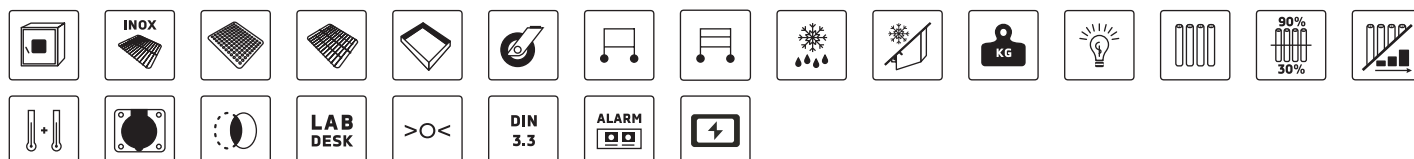

ADVANTAGES OF PELTIER-COOLED INCUBATORS



Environmentally friendly

Elimination of compressor and refrigerants ensures environmental protection.



Lighter and smaller

The Peltier-element system has reduced the size and weight of the unit.



Vibration-free

With the introduction of the Peltier-element system, vibrations previously generated by the compressor have been eliminated.



Perfect performance

The cooling system based on the Peltier-element features excellent temperature stability and uniformity. It also improves the temperaturerecovery time (e.g. after door opening).



Energy saving

When operating the unit at temperatures close to the ambient temperature, the electricity cost are reduced on average by 40 %

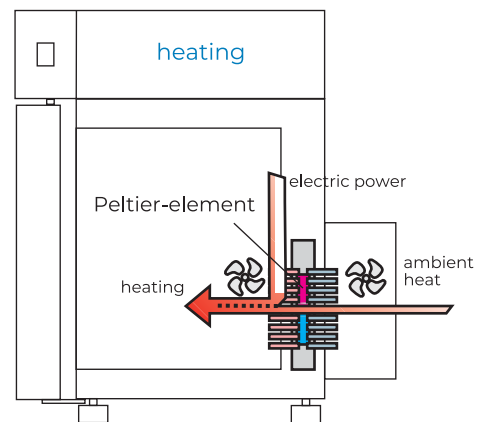
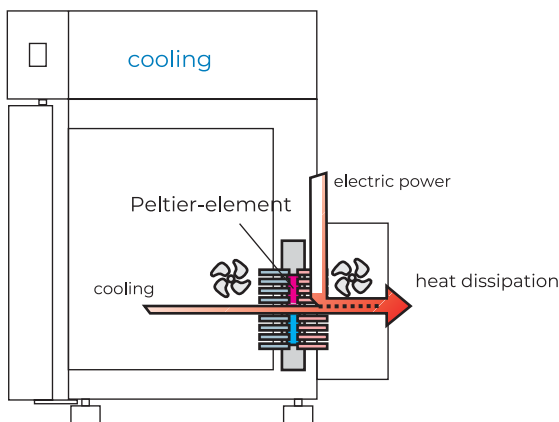

STANDARD FEATURES

- temperature range 0...+70°C
- English instruction manual
- temperature protection class 2.0 (Smart) and 3.3. (Smart PRO) to DIN 1288
- open door alarm
- castors in standard for ILP 750 model
- LAN and USB ports
- internal LED light
- access port (Ø30 mm) on the left wall
- door lock
- stainless steel wire shelves (INOX)
- double door (external solid, internal glass)

EXTRA FOR SMART PRO





- Wi-Fi
- LAN cable
- LabDesk

AVAILABLE VERSIONS

- Smart
- Smart PRO

SOFTWARE

- LabDesk for data download to a PC via LAN or Wi-Fi (optional for Smart version)

		ILP 53	ILP 115	ILP 240	ILP 750
Parameter					
air convection		forced			
chamber capacity [l]		56	112	245	749
door type		double ¹ / door with viewing window (option)			
temperature range [°C]		0...+70 (max 20°C below ambient temperature)			
temperature resolution [°C]		every 0,1			
controller		microprocessor PID, 4,3" (Smart) / 7" (Smart PRO) full colour touch screen			
interior		acid-proof stainless steel to DIN 1.4301			
housing		powder coated sheet			
		IC stainless steel linen finish			
overall dims ² [mm]	A width	590	650	820	1260
	B height	710	850	1140	1580
	C depth	690	780	840	1040
internal dims [mm]	D width	400	460	600	1040
	E height	390	540	800	1200
	F depth	360	450	510	600
max shelf workload ³ [kg]		25	25	25	-
max reinforced shelf workload (PW) ³ [kg]		-	-	-	100
max unit workload [kg]		50	50	90	140
nominal power [W]		500	650	800	1400
weight [kg]		69	90	140	240
temperature fluctuation* at +37°C [± °C]		0,1	0,1	0,1	0,1
temperature variation* at +37°C [± °C]		0,2	0,2	0,3	0,3
temperature protection		class 2.0 to DIN 12880 / class 3.3 (option) / 3.3 in Smart PRO			
power supply**		230V 50-60Hz			
shelves fitted/max		2/5	2/7	3/10	5/16
warranty		24 months			
manufacturer		POL-EKO			

all the above technical data refer to standard units (without optional accessories)

* - fluctuation measured in centre of chamber; in space, variation (K) calculated for chamber as: $K = \pm (T_{avg\ max} - T_{avg\ min}) / 2$

** - other power supplies on request

1- internal glass door, external solid

2- depth does not include 50 mm of power cable

3- on uniformly loaded surface

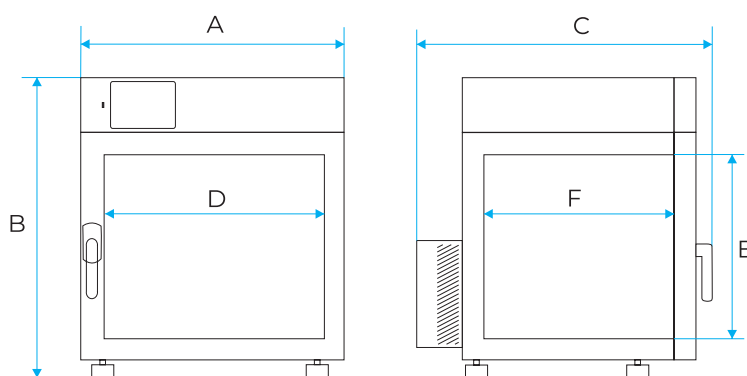

Options and accessories (icon description see pages 80-86)

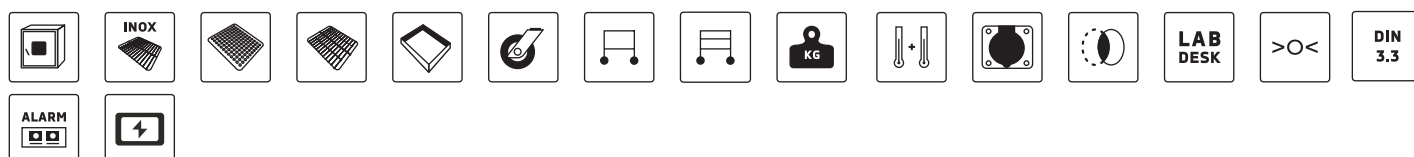

Equipment with photoperiod

- The photoperiodic (FOT) and phytotron (FIT) systems allow day and night simulation in ST and ILW cooled incubators. The basic difference between the FOT and FIT functions is that in the first case, the light can only be turned on and off in the program, and in the second, you can additionally control its intensity.

The ST and ILW cooled incubators in Smart versions can be equipped with the FOT system.

FOT option advantages

- day and night simulation software - for each segment it is possible to program temperature, duration time, fan and light efficiency (ON / OFF)
- temperature range for "night": +3°C... +50°C and -10°C... +50°C (for IL with ILW/T option)
- temperature range for "day": +10°C...+50°C
- 840 fluorescent tube lamps installed in side walls in ST cooled incubators; in door or ceiling in ILW cooled incubators
- with FOT option the equipment operates with time priority (see page 83)
- automatic defrosting function in standard

Photoperiod (FOT option)

	ST FOT2	ST FOT4	ST FOT6	ST FOT8	ST FOT10	ST FOT15	IL FOT2S	IL FOT3S	IL FOT5D	IL FOT6D	IL FOT8D	IL FOT10D
available for models	ST1 ST1/1 ST1/1/1	ST2 ST2/2	ST2 ST3 ST2/2	ST4 ST5	ST500 ST700	ST1200 ST1450	ILW53	ILW115	ILW53	ILW115 ILW240	ILW240 ILW400 ILW750	ILW750
temperature range with photoperiod [°C]	+10 ... +50											
number of lamps in door	-	-	-	-	-	-	-	-	5	6	8	10
number of lamps in ceiling	2	-	-	-	-	-	2	3	-	-	-	-
number of lamps in side walls	-	4	6	8	10	15	-	-	-	-	-	-
adjustable illumination intensity	no											

*for the ST series with the FOT option, the internal dimensions of the chamber are reduced by 4 cm on each side, the FOT option must be ordered together with the equipment! It is not possible to purchase this option later.

Application

- microbiological tests
- plant growing, microorganisms breeding at precisely controlled environment
- photostability tests



Equipment with phytotron

■ The ST and ILW cooled incubators in Smart PRO version (ST 500/700/1200/1450, ILW 115/240/400/750) and climatic chambers can be equipped with the FIT system.

FIT option advantages

- day and night simulation software - for each segment it is possible to program temperature, duration time, fan efficiency and light intensity (every 10%)
- temperature range for "night": +3°C... +60°C (ST) and -10°C... +60°C (for IL with ILW/T option)
- temperature range for "day": +10°C...+50°C
- lamps installed in over-shelf panels (FIT P), in side walls (FIT S), in door (FIT D) or in door and side walls (FIT DS)
- 840 fluorescent tube lamps (daylight) or LED modules
- with FIT option the equipment can operate with time or parameters (temperature) priority
- automatic defrosting function in standard

Phytotron (FIT option)

Option*	ST 500/700 FIT DS	ST 500/700 FIT S	ST 500/700 FIT P	ST 1200 FIT P	ST 1450 FIT P	IL 115 FIT P	IL 240 FIT P	IL 400 FIT P	IL 750 FIT P	IL 115 FIT D	IL 240 FIT D	IL 750 FIT D
temperature range with phytotron ON [°C]	+10 ... +50											
number of over-shelf panels with illumination (std/max)	-	-	1/3	1/3	1/3	1/1	1/2	1/2	1/3	-	-	-
lamps in door	yes	-	-	-	-	-	-	-	-	yes	yes	yes
lamps in side walls	yes	yes	-	-	-	-	-	-	-	-	-	-
adjustable illumination intensity	yes											

* **FIT DS** – illumination in door and side walls; **FIT D** - illumination in door; **FIT S** – illumination in side walls; **FIT P** – illumination in over-shelf panels

ST cooled incubators ST 500, 700, 1200, 1450 with FIT/FOT option are produced with previous cooling system. It is not possible to supply them with monoblock (M) cooling unit.

Application

- growth of plants and fungus
- seeds germination
- microorganisms and insects breeding
- photostability tests
- food preservation tests
- any kind of research that requires a stable temperature light control (optionally humidity control)
- tests of building materials



BOD incubators

- The ST BD cooled incubators series for biochemical oxygen demand (BOD) determination, is adapted to work with OxiTop® systems. ST BD series cabinets are equipped with internal power sockets 2, 3 or 4, depending on the model, and it is possible to place inside them respectively 2, 3 or 4 OxiTop® IS 12 sets by WTW.



ST BD 2 Smart



ST BD 4 Smart



ST BD 5 Smart

ADVANTAGES OF ST BD COOLED INCUBATORS

- Smart controller
- heating and cooling system
- temperature range + 3... + 40°C
- temperature resolution every 0.1°C
- forced air convection
- solid door (optional external glass door)
- access port (Ø30 mm) on the left wall
- internal socket
- open door alarm
- internal LED light
- housing material - powder coated sheet
- chamber material - aluminum
- door lock
- wire shelves with guides
- visual and sound alarm
- temperature sensor damage alarm
- voltage decay control
- real time clock

Determination of:

- BOD
- biological decomposition
- oxygen consumption
- complete aerobic biodegradation





HEATING EQUIPMENT

Laboratory incubators are perfect for incubation of samples at temperatures above ambient up to +100°C



CLN 180 IG Smart PRO laboratory incubator



All thermostatic equipment manufactured by POL-EKO can be provided with Calibration Certificate issued by accredited Measurement Laboratory. Detailed information on accreditation is available on website: www.pol-eko.eu.

Hundreds of products in our offer equal hundreds of thousands of elements that the final product consists of. Most of them are produced at our premises in Wodzisław Śląski and this requires continuous availability of materials, raw materials and ready-made components supplied to us. Ensuring the continuity of production and proper quality of parts manufactured for us in many countries in the world is crucial. That is why all these processes must be monitored and verified up to date. To guarantee highest quality of supplied elements every supplier is periodically evaluated.



STANDARD FEATURES

- temperature range 5°C above ambient temperature...+100°C
- quality control protocol (at +37°C)
- English instruction manual
- temperature protection class 2.0 (Smart) and 3.3 (Smart PRO) to DIN 12880
- open door alarm
- castors in standard for models CL 400, 750, 1000
- Ø40 mm air-flap for CL 15-180 and Ø60 mm for CL 240-1000
- LAN and USB ports
- access port: Ø30 mm for models 53-1000 or Ø9 mm for models 15, 32 on the left wall
- door lock
- stainless steel wire shelves (INOX)
- double door (external solid, internal glass)

EXTRA FOR SMART PRO

- Wi-Fi
- LAN cable
- LabDesk

AVAILABLE VERSIONS

- Smart
- Smart PRO
- reinforced









SOFTWARE

- LabDesk for data download to a PC via LAN or Wi-Fi (optional for Smart version)

Application

- incubation of samples for microbiological determinations
- analysis of thermal resistance of samples subjected to higher temperatures
- antibodies tests
- bacteria tests
- crystallization observations
- cultivation of thermophilic microorganisms
- pharma stability tests
- food industry denaturalizing tests



		CL 15	CL 32	CL 53	CL 115	CL 180	CL 240	CL 400	CL 750	CL 1000	
Parameter											
air convection		natural (CLN) / forced (CLW)						forced (CLW)			
chamber capacity [l]		15	32	56	112	180	245	424	749	1005	
door type		double ¹		double ¹ / door with viewing window (option)							
temperature range		+5°C above ambient temperature ...+100°C									
temperature resolution [°C]		every 0,1									
controller		microprocessor PID, 4,3" (Smart) / 7" (Smart PRO) full colour touch screen									
interior		acid-proof stainless steel to DIN 1.4301									
housing	-	powder coated sheet									
	IG	stainless steel linen finish									
overall dims ² [mm]	A width	510	590	590	660	660	820	1020	1260	1260	
	B height	550	630	710	850	1040	1140	1430	1600	2000	
	C depth	470	520	620	710	820	770	770	880	880	
internal dims [mm]	D width	320	400	400	460	470	600	800	1040	1040	
	E height	230	320	390	540	720	800	1040	1200	1610	
	F depth	200	250	360	450	560	510	510	600	600	
max shelf workload ⁵ [kg]	-	10	10	25	25	25	25	25	-	-	
	PW ³ version	-	-	50	50	50	100	100	100	100	
max unit workload [kg]	-	20	30	40	60	75	90	120	140	-	
	W ⁴ version	-	-	80	120	120	300	300	300	300	
nominal power [W]		350	350	450	450	650	850	1300	1900	1900	
weight [kg]		32	35	50	65	92	118	170	260	319	
temperature fluctuation* at +37°C [± °C]	CLN	0,2	0,2	0,2	0,2	0,2	0,3	-	-	-	
	CLW	0,2	0,2	0,1	0,1	0,1	0,1	0,1	0,1	0,2	
temperature variation* at +37°C [± °C]	CLN	0,7	0,7	0,7	0,8	0,8	0,8	-	-	-	
	CLW	0,4	0,4	0,3	0,3	0,3	0,3	0,5	0,5	1,0	
over temperature protection		class 2.0 to DIN 12880 / class 3.1 (option) / class 3.1 in Smart PRO									
power supply**		230V 50-60Hz									
shelves fitted/max		1/2	1/3	3/9	2/7	3/9	3/10	3/14	5/16	6/22	
warranty		24 months									
manufacturer		POL-EKO									

all the above technical data refer to standard units (without optional accessories)

* - fluctuation measured in centre of chamber; in space, variation (K) calculated for chamber as: $K = \pm (T_{avg\ max} - T_{avg\ min}) / 2$

** - other power supplies on request

1 - internal glass, external solid

2 - depth doesn't include 50 mm of power cable

3 - reinforced shelf

4 - reinforced version

5 - on uniformly loaded surface

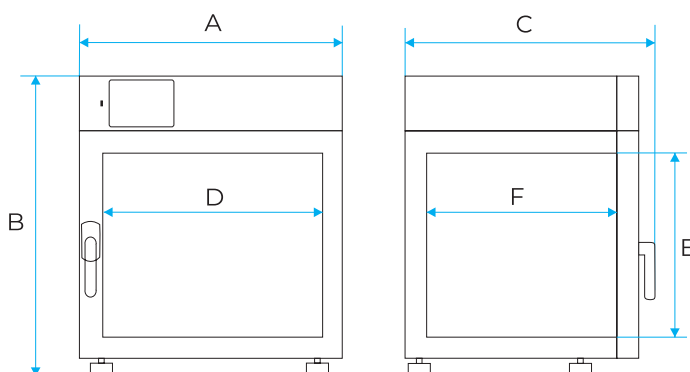

Options and accessories (icon description see pages 80-86)

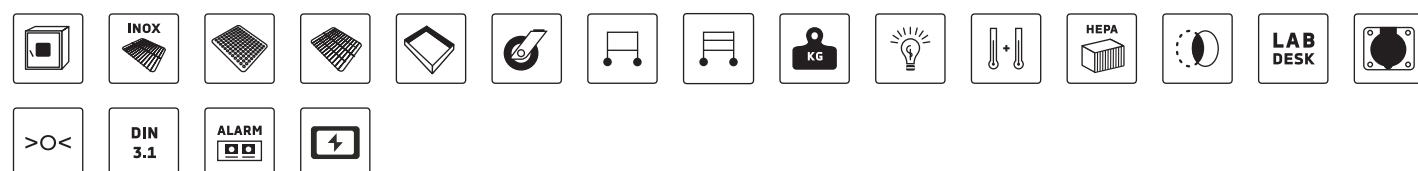

Drying ovens are designed to provide high temperatures up to 300°C



Drying oven SLW 1000 IG Smart PRO



All thermostatic equipment manufactured by POL-EKO can be provided with Calibration Certificate issued by accredited Measurement Laboratory. Detailed information on accreditation is available on website: www.pol-eko.eu.

Such a wide range of products and sale to so many different markets requires extensive knowledge of tax regulations. We are supported in this regard by the ERP integrated management system implemented in 2019 and the involvement of employees of all departments of our company. Data flow and correct system configuration allows precise determination of costs of the tiniest elements and controlling of all processes.



STANDARD FEATURES

- temperature range 5°C above ambient temperature...+300°C
- quality control protocol (at +105°C)
- English instruction manual
- temperature protection class 2.0 (Smart) and 3.1 (Smart PRO) to DIN 12880
- open door alarm
- castors in standard for models SL 400, 750, 1000
- Ø40 mm air-flap for SL 15-180 and Ø60 mm for SL 240-1000
- LAN and USB ports
- access port: Ø30 mm for models 53-1000 or Ø9 mm for models 15, 32 on the left wall
- door lock
- stainless steel wire shelves (INOX)
- solid door

EXTRA FOR SMART PRO

- Wi-Fi
- LAN cable
- LabDesk

AVAILABLE VERSIONS

- Smart
- Smart PRO
- reinforced
- SIMPLE
- with nitrogen blow

SOFTWARE

- LabDesk for data download to a PC via LAN or Wi-Fi (optional for Smart version)

Application

- thermal resistance analysis of building materials, electronic and electro-technical components
- tests of properties of products subjected to high temperatures
- drying of wires of papermaking machines
- drying of laboratory glass
- general aging
- preheating
- digestion of proteins
- plant tissues drying
- drug metabolism
- paper drying

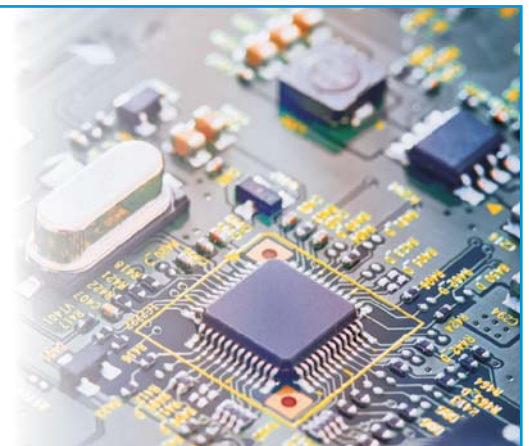

		SL 15	SL 32	SL 53	SL 75	SL 115	SL 180	SL 240	SL 400	SL 750	SL 1000	
Parameter												
air convection		natural (SLN) / forced (SLW)							forced (SLW)			
chamber capacity [l]		15	32	56	75	112	180	245	424	749	1005	
door type		solid			solid/door with viewing window (option)							
temperature range		+5°C above ambient temperature ...+300°C										
temperature resolution [°C]		every 0,1										
controller		microprocessor PID, 4,3" (Smart) / 7" (Smart PRO) full colour touch screen										
interior		acid-proof stainless steel to DIN 1.4301										
housing	-	powder coated sheet										
	IG (Inox/G)	stainless steel linen finish										
overall dims ¹ [mm]	A width	510	590	590	590	660	660	820	1020	1260	1260	
	B height	550	640	710	850	850	1040	1140	1430	1600	2000	
	C depth	470	520	620	620	710	820	770	770	880	880	
internal dims [mm]	D width	320	400	400	400	460	470	600	800	1040	1040	
	E height	230	320	390	530	540	720	800	1040	1200	1610	
	F depth	200	250	360	360	450	560	510	510	600	600	
max shelf workload ⁴ [kg]	-	10	10	25	25	25	25	25	25	-	-	
	PW ² version	-	-	50	50	50	50	100	100	100	100	
max unit workload [kg]	-	20	30	40	40	60	75	90	120	140	-	
	W ³ version	-	-	80	80	120	120	300	300	300	300	
nominal power [W]		700	1200	1700	1700	2500	2500	3100	4000	5500	5500	
weight ⁵ [kg]		31	35	48	60	65	88	114	162	260	307	
temperature fluctuation* at +105°C [± °C]	SLN	0,4	0,4	0,4	-	0,4	0,4	0,6	-	-	-	
	SLW	0,3	0,3	0,2	0,2	0,2	0,2	0,4	0,4	0,6	0,6	
temperature variation* at +105°C [± °C]	SLN	2,5	2,5	2,0	-	2,2	2,3	2,5	-	-	-	
	SLW	2,0	2,0	2,0	2,0	2,0	2,0	2,0	2,5	2,5	3,0	
over temperature protection		class 2.0 to DIN 12880 / class 3.1 (option) / class 3.1 in Smart PRO										
power supply**		230V 50-60Hz							400V 50-60Hz			
shelves fitted/max		1/2	1/3	2/5	2/5	2/7	3/9	3/10	3/14	5/16	6/22	
warranty		24 months										
manufacturer		POL-EKO										

all the above technical data refer to standard units (without optional accessories)

* - fluctuation measured in centre of chamber; in space, variation (K) calculated for chamber as: $K = \pm (T_{avg\ max} - T_{avg\ min}) / 2$

** - other power supplies on request

1 - depth doesn't include 50 mm of power cable

2 - reinforced shelf

3 - reinforced version

4 - on uniformly loaded surface

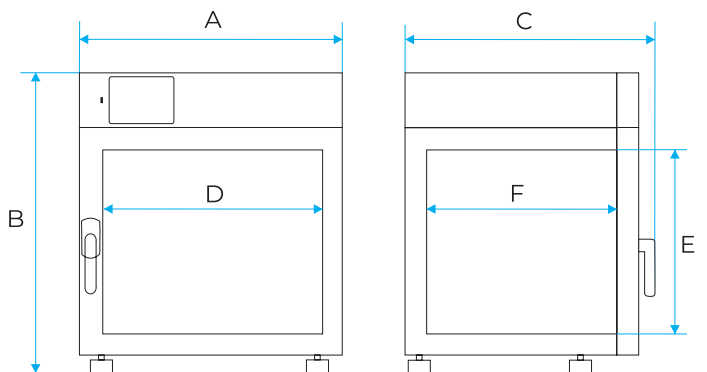

Options and accessories (icon description see pages 80-86)

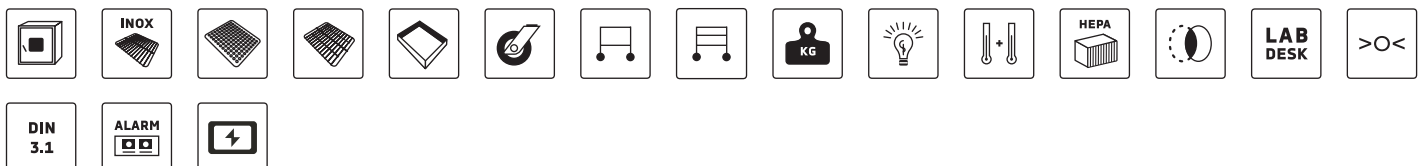

Drying ovens with nitrogen blow

The PN-ISO 589:2006 norm on the determination of total moisture in hard coal requires that samples of coal subject to oxidation are dried at a temperature of + 105 ° C in a nitrogen flow drying oven.

Detailed requirements and specification of the oven have been described in point 6 of the norm. Use a "nitrogen flow drying oven, allowing to control the temperature in the range from + 105 ° C to + 110 ° C with additional possibility of blowing dry nitrogen stream, at a flow rate of about 15 dryer volumes per hour ”.

To meet these requirements, we have developed a special version of drying ovens that can operate strictly as per the above standard.

Available models

- SLWN1 - laboratory oven with dry nitrogen blow system of the chamber; the kit includes connections, valves and a laboratory rotameter (which can be calibrated)
- SLWN2 - laboratory oven with dry nitrogen blow system of the chamber; the kit includes connections, valves and a tech rotameter (which cannot be calibrated)

The nitrogen bottle is not supplied.

	SLWN1 15 SLWN2 15	SLWN1 32 SLWN2 32	SLWN1 53 SLWN2 53	SLWN1 115 SLWN2 115	SLWN1 240 SLWN2 240
chamber capacity ¹ [l]	15	32	56	112	245

1 - working capacity of chamber can be smaller

For dimensions see page 53 (models SLW 15, 32, 53, 115, 240).



Calibration

- Calibration in air in 9 points (corners + geometrical center) of the chamber at 1 selected by the customer temperature in accredited laboratory. Calibration is confirmed by 'Calibration certificate'.
- Calibration in nitrogen in 9 points (corners + geometrical center) of the chamber at 1 selected by the customer temperature in accredited laboratory. Calibration is confirmed by 'Calibration certificate'.
- Calibration of laboratory rotameter in accredited laboratory. Calibration is confirmed by 'Calibration certificate'.

SIMPLE drying oven

Simple in operation laboratory drying oven – convenient unit for customers who do not require advanced programming. The equipment is based on a simple controller that allows you to set the temperature and continuous operation.

Selling the equipment to all continents of the world is a huge challenge for all the staff responsible for order processing and delivery of products on time. But the knowledge of regulations, customs procedures and experience of our employees gained over the years thanks to cooperating with our distributors guarantees professional service of every single order.







STANDARD FEATURES

- temperature range: +5°C above ambient temperature... +250°C
- quality control protocol (at +105°C)
- English instruction manual
- temperature protection 1.0 class to DIN 12880
- access port (Ø30 mm) on the right wall
- stainless steel wire shelves (INOX)
- solid door
- continuous operating

Application

- tests of thermal resistance of building materials, electronic and electrotechnical parts
- checking the influence of high temperature on the properties of products
- drying laboratory glassware
- pre-heating



		SLN 53 SIMPLE	SLN 115 SIMPLE	SLW 53 SIMPLE	SLW 115 SIMPLE
Parameter					
air convection		natural	forced	natural	forced
chamber capacity [l]		56	109	56	109
door type		solid			
temperature range		+5°C above ambient temperature ...+250°C			
temperature resolution [°C]		every 0,1			
controller		microprocessor PID, 4,3" (Smart) / 7" (Smart PRO) full colour touch screen			
interior		stainless steel to DIN 1.4016			
housing		powder coated sheet			
overall dims [mm]	A width	660	720	660	720
	B height	590	730	590	730
	C depth	620	710	620	710
internal dims [mm]	D width	390	460	390	460
	E height	390	540	390	540
	F depth	350	440	350	440
max shelf workload [kg]		10	10	10	10
max unit workload [kg]		40	60	40	60
nominal power [W]		1700	2500	1700	2500
weight [kg]		46	64	46	64
temperature fluctuation* at +105°C [± °C]		0,3	0,3	0,3	0,3
temperature variation* at +105°C [± °C]		2,5	2,5	1,5	1,5
over temperature protection		class 1.0 to DIN 12880			
power supply**		230V 50-60Hz			
shelves fitted/max		2/5	2/7	2/5	2/7
warranty		24 months			
manufacturer		POL-EKO			

all the above technical data refer to standard units (without optional accessories)

* - fluctuation measured in centre of chamber; in space, variation (K) calculated for chamber as: $K = \pm (T_{avg\ max} - T_{avg\ min}) / 2$

** - other power supplies on request

1-depth doesn't include 50mm of power cable

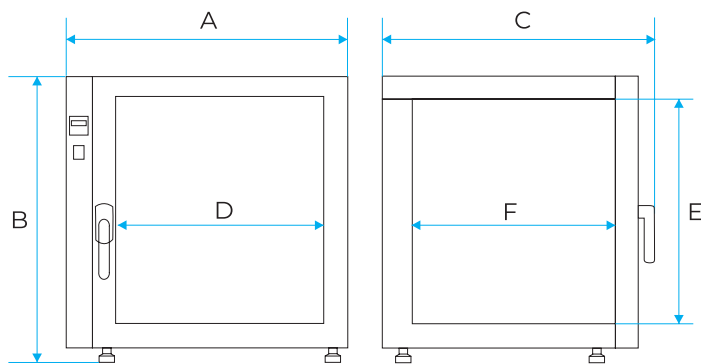

Options and accessories (icon description see pages 80-86)



Hot-air sterilizers have been equipped with a couple of additional functions that protect samples. They can sterilize at temperatures of up to 250°C



Sterilizer SRW 240 IG Smart



All thermostatic equipment manufactured by POL-EKO can be provided with Calibration Certificate issued by accredited Measurement Laboratory. Detailed information on accreditation is available on website: www.pol-eko.eu.

The highest level of customer service is our priority. Our goal is to be a consulting company. We do our best to ensure that our sales department staff are not only simply sales people but also engineers whose knowledge and experience would allow to find the best solution for each application. It is our philosophy. We never leave our customers without support. We approach them with great attention to appreciate their trust in us. Always there to help – we advise, train and make suggestions to our colleagues from the R&D department what needs arise in the market and what solutions the customers expect.



STANDARD FEATURES

- temperature range: +5°C above ambient temperature... +250°C
- other features like for drying ovens SL (see page 52)

AVAILABLE VERSIONS

- Smart
- Pass-through sterilizers

ADVANTAGES OF SR HOT-AIR STERILIZERS

- pre-set sterilization programs (including mask sterilization program)
- automatic door lock during the sterilization program
- automatically closed air-flap after starting the sterilization program
- 5 user programs and 3 pre-set programs







SOFTWARE

- LabDesk for data download to a PC via LAN or Wi-Fi (optional for Smart version)

Application

- hot air sterilization
- disinfection of masks, documents, etc.



		SR 53	SR 115	SR 240	SR 400	SR 750	SR 1000
Parameter							
air convection		natural (SRN) / forced (SRW)			forced (SRW)		
chamber capacity [l]		56	112	245	424	749	1005
door type		solid/door with viewing window (option)					
temperature range		+5°C above ambient temperature ...+250°C					
temperature resolution [°C]		every 0,1					
controller		microprocessor PID, 4,3" (Smart) / 7" (Smart PRO) full colour touch screen					
interior		acid-proof stainless steel to DIN 1.4301					
housing	-	powder coated sheet					
	IG	stainless steel linen finish					
overall dims [mm]	A width	590	660	820	1020	1260	1260
	B height	710	850	1140	1430	1600	2000
	C depth	620	710	770	770	880	880
internal dims [mm]	D width	400	460	600	800	1040	1040
	E height	390	540	800	1040	1200	1610
	F depth	360	450	510	510	600	600
max shelf workload ³ [kg]	-	25	25	25	25	-	-
	PW ² version	50	50	100	100	100	100
max unit workload [kg]		40	60	90	120	140	300
nominal power [W]		1700	2500	3100	4000	5500	5500
weight ⁵ [kg]		48	65	114	162	260	307
temperature fluctuation* at +105°C [± °C]	SRN	0,4	0,4	0,6	-	-	-
	SRW	0,2	0,2	0,3	0,4	0,6	0,6
temperature variation* at +105°C [± °C]	SRN	2,0	2,2	2,5	-	-	-
	SRW	2,0	2,0	2,0	2,5	2,5	3,0
over temperature protection		class 2.0 to DIN 12880 / class 3.1 (option)					
power supply**		230V 50-60Hz			400V 50-60Hz		
shelves fitted/max		2/5	2/7	3/10	3/14	5/16	6/22
warranty		24 months					
manufacturer		POL-EKO					

all the above technical data refer to standard units (without optional accessories)

* - fluctuation measured in centre of chamber; in space, variation (K) calculated for chamber as: $K = \pm (T_{avg\ max} - T_{avg\ min}) / 2$

** - other power supplies on request

1 - depth doesn't include 50 mm of power cable

2 - reinforced shelf

3 - on uniformly loaded surface

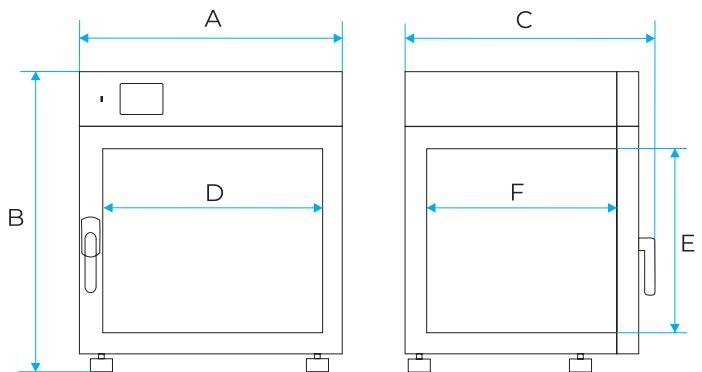

Options and accessories (icon description see pages 80-86)

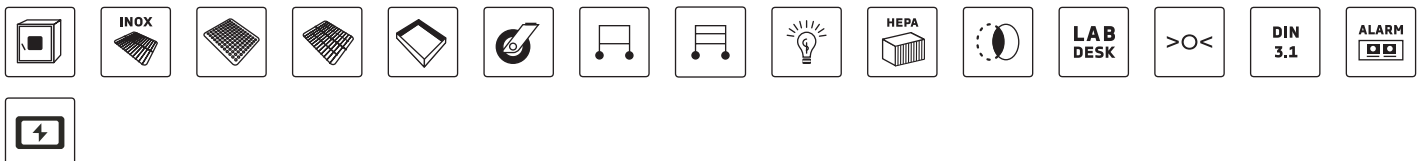

Pass-through sterilizers are made on the basis of standard laboratory sterilizers. They are used on production lines as well for sterilization between clean and dirty areas.



STANDARD FEATURES

- temperature range: +5°C above ambient temperature... +250°C
- quality control protocol (at +105°C)
- English instruction manual
- temperature protection class 2.0 (Smart), 3.1 (option) to DIN 12880
- open door alarm
- LAN and USB ports
- access port: Ø30 mm on the left wall
- door lock
- stainless steel wire shelves (INOX)
- solid door on both sides
- pre-set sterilization programs
- automatic door lock during the sterilization program
- automatically closed air-flap after starting the sterilization program
- 5 user programs and 3 pre-set programs

AVAILABLE VERSIONS

- Smart

SOFTWARE

- LabDesk for data download to a PC via LAN (option)

Application

- connection between dirty and clean areas
- drying/sterilisation on production lines
- hot-air sterilisation





SRWP 115



SRWP 240



Parameter			
air convection		forced	forced
chamber capacity [l]		105	240
door type		solid	
temperature range		+5°C above ambient temperature ...+250°C	
temperature resolution [°C]		every 0,1	
controller		microprocessor PID, 4,3" (Smart) / 7" (Smart PRO) full colour touch screen	
interior		acid-proof stainless steel to DIN 1.4301	
housing		powder coated sheet	
overall dims [mm]	A width	700	840
	B height	910	1170
	C depth	700	770
internal dims [mm]	D width	460	600
	E height	530	800
	F depth	430	500
max shelf workload [kg]		10	10
PW version [kg]		50	100
max unit workload [kg]		60	90
nominal power [W]		2500	3000
weight [kg]		65	126
over temperature protection		class 2.0 to DIN 12880 / class 3.1 (option)	
power supply**		230V 50-60Hz	
shelves fitted/max		2/7	3/10
warranty		24 months	
manufacturer		POL-EKO	

all the above technical data refer to standard units (without optional accessories)

* - fluctuation measured in centre of chamber; in space, variation (K) calculated for chamber as: $K = \pm (T_{avg\ max} - T_{avg\ min}) / 2$

** - other power supplies on request

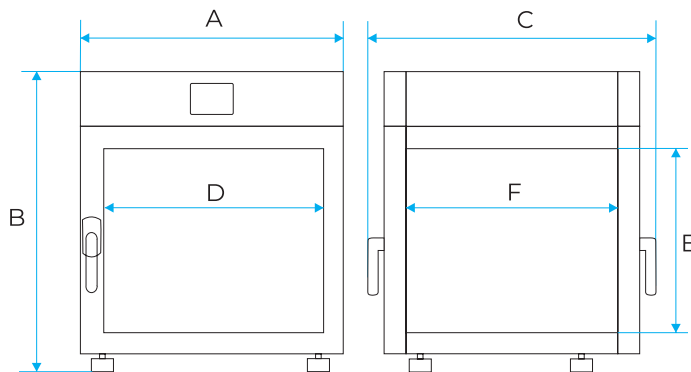

Options and accessories (icon description see pages 80-86)



Caldera is a warming chamber for fluids and blankets



CALDERA 250 INOX



All thermostatic equipment manufactured by POL-EKO can be provided with Calibration Certificate issued by accredited Measurement Laboratory. Detailed information on accreditation is available on website: www.pol-eko.eu.

We are already present in over 90 countries of the whole world, but still work hard to grow and expand our business. Our goal is to offer the products and solutions to customers from any corner of the globe and make the brand even stronger. To achieve this, we must guarantee professional support and highest level of customer service on site, in the mother tongue. This is the reason why we cooperate closely with local distributors all over the world. They can reach the end users on our behalf and provide them with assistance, advice and care.



FUNCTIONALITY

- capacities: 70, 150, 200, 250, 300l – dimensions and load examples are specified in the table with technical data
- fast heating-up of the load due to forced air convection
- polished stainless steel housing, stainless steel interior
- bright, energy saving LED internal lighting and tempered glass of the door assure an excellent visibility of the interior
- stainless steel telescopic drawers to prevent the load falling or stainless steel wire shelves in TERM version
- optional stainless steel table

SAFETY





- safe temperature range: +35°C ... +42°C or +35°C ... +70°C in TERM version, temperature regulation every 1°C
- visual and audible alarm in case set temperature is exceeded for 2°C
- independent temperature protection over 45°C (over temperature protection); 3.1 class according to DIN 12880
- open door alarm (the alarm goes off in case the door is opened for over 1 minute)
- LED display visible from 4 m distance
- door lock – load protection against unauthorized use
- service settings protection against unauthorized use
- internal memory for data storage

CALDERA was designed according to PN-EN 60601-1-2:2002 EMC – Medical norm for electrical equipment (it does not interrupt the work of the other medical instruments).



All thermostatic equipment manufactured by POL-EKO can be provided with Calibration Certificate issued by accredited Measurement Laboratory. Detailed information on accreditation is available on website: www.pol-eko.eu.

CALDERA 70 CALDERA 150 CALDERA 200 CALDERA 250 CALDERA 300

						
air convection		forced				
chamber capacity ¹ [l]		70	150	200	250	300
door type		door with viewing window				
temperature range [°C]		+35...+42 (+35...+70 in TERM version)				
temperature resolution [°C]		every 1,0				
controller		microprocessor PID, 4,3" full colour touch screen				
interior		acid-proof stainless steel to DIN 1.4301				
housing		polished stainless steel				
overall dims ² [mm]	A width	550	600	600	600	600
	B height	640	840	1040	1240	1440
	C depth	530	630	630	630	630
internal dims [mm]	D width	450	490	490	490	490
	E height	410	650	850	1050	1250
	F depth	380	480	480	480	480
examples of fluid bags configurations bottle x bottle capacity [l] (per drawer)		20 x 1 or 30 x 0,5 or 4 x 3				
alarm		visual and sound after exceeding the set temperature by 2°C				
lighting		energy-saving LED chamber lighting				
maximum number of drawers (without shelves)		1	2	2	3	4
maximum drawer load [kg]		20	20	20	20	20
max unit workload [kg]		20	40	40	60	80
nominal power [W]		250	250	250	250	250
weight [kg]		32	54	59	69	75
temperature fluctuation* at +37°C [± °C]		0,3	0,3	0,3	0,3	0,3
temperature variation* at +37°C [± °C]		0,5	0,5	0,5	0,5	0,5
time required to achieve 37°C of the load, at set 37°C (40% load)		4,5 ... 6 h				
time required to achieve 37°C of the load, at set 37°C (70% load)		10 ... 15 h				
over temperature protection		temperature protection over 45°C (class 3.1 to DIN 12880)				
power supply**		230V 50-60Hz				
number of shelves in TERM version		1	2	2	3	4
warranty		24 months				
manufacturer		POL-EKO				

all the above technical data refer to standard units (without optional accessories)

* - fluctuation measured in centre of chamber; in space, variation (K) calculated for chamber as: $K = \pm (T_{avg\ max} - T_{avg\ min}) / 2$

** - other power supplies on request

1 - working capacity of chamber can be smaller

2 - depth doesn't include 50 mm of power cable

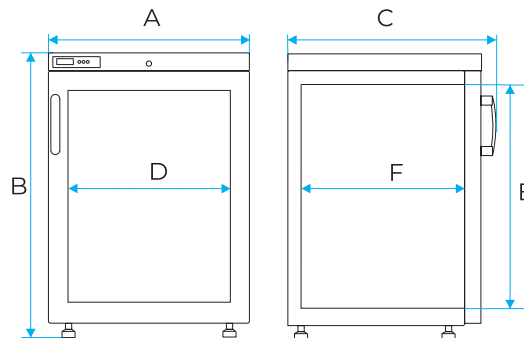

Options and accessories (icon description see pages 80-86)





CO₂ INCUBATORS

The CO₂ incubator offers optimum growth conditions for cell cultures. Very precise temperature control, optimal humidity and CO₂ concentration are undeniable advantages of this product.

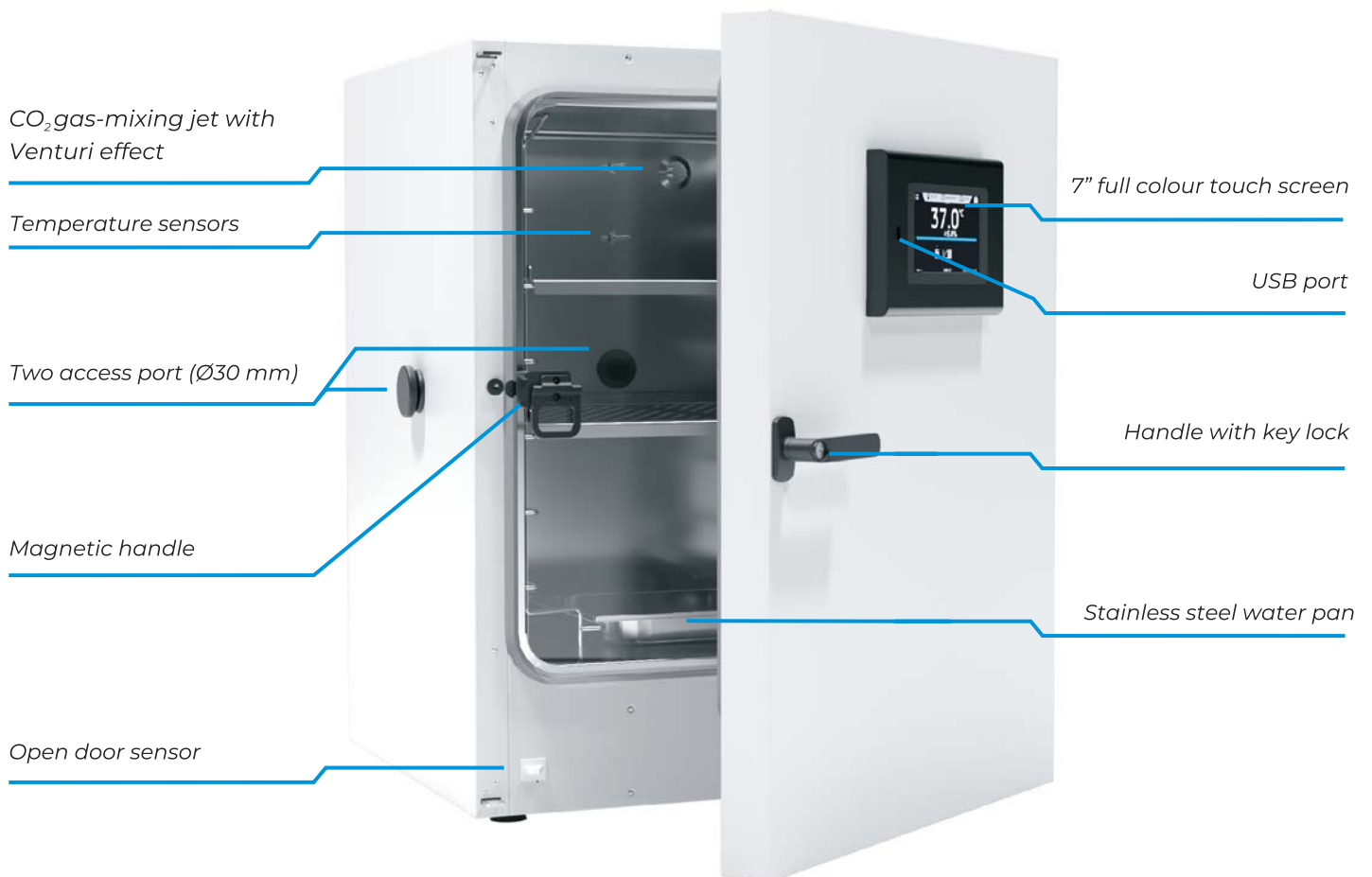

CO₂ Incubator ILC 180 Smart PRO



All thermostatic equipment manufactured by POL-EKO can be provided with Calibration Certificate issued by accredited Measurement Laboratory. Detailed information on accreditation is available on website: www.pol-eko.eu.

We are constantly working on development not only of our equipment but also of new products. The CO₂ incubator is our youngest "child" of which we are very proud. We present you a product based on the latest technological solutions, using only top-shelf components. We are convinced that you will appreciate the high quality of our solution.



STANDARD FEATURES

- Temperature range +5°C...+50°C
- Quality control certificate (at +37°C, 5% CO₂)
- English instruction manual
- Temperature protection class 3.2 to DIN 12880
- Open door alarm
- LAN and USB ports
- Height adjustable feet
- Two access ports (Ø30 mm) on the left wall and on the rear, both secured with silicone plugs
- Water pan to provide optimal humidity
- Door lock
- Perforated shelves and rack for them to optimal shelf positioning
- Open door sensor
- Silicone gasket
- Magnetic handle for ergonomic internal door opening
- Main power switch incorporated in housing prevents unintentional switch off
- CO₂ gas-mixing jet with Venturi effect to ensure quicker atmosphere mixing and more homogeneous distribution
- Multiple temperature sensors for accurate measurement
- Wi-Fi
- LAN cable
- LabDesk

CONTAMINATION PROTECTION:

- Hot-air sterilization at 180°C
- Fan-less construction
- Smooth, easy to clean stainless steel interior with rounded corners
- Sterilizable, drift-free Infrared CO₂ sensor
- Inner glass door for sample viewing without changing the conditions in the chamber
- No hidden spaces

AVAILABLE VERSIONS

- Smart PRO

SOFTWARE

- LabDesk for data download to a PC via LAN or Wi-Fi

Application:

- cell cultures
- bacterial cultures
- tissue cultures



ILC 180



Parametr		
air convection		natural (fam less)
chamber capacity ¹ [l]		182
working capacity ² [l]		135
door type		double (external solid + internal glass)
temperature range [°C]		+5°C above ambient temperature...+50
temperature resolution [°C]		every 0,1
humidity range [% rH]		90-95
CO ₂ range[%]		0-20
CO ₂ resolution [%]		every 0,1
CO ₂ measurement		IR
controller		microprocessor PID, 4,3" full colour touch screen
interior		acid-proof stainless steel to DIN 1.4301
housing		powder coated sheet
overall dims ² [mm]	A width	700
	B height	920
	C depth	780
internal dims [mm]	D width	560
	E height	650
	F depth	500
maximum drawer load [kg]		10
max unit workload [kg]		30
nominal power [W]		1700
weight [kg]		96
temperature fluctuation* at 37°C [°C]		< ± 0,1
temperature variation* at 37°C [°C]		< ± 0,3
time required to achieve 37°C of the load, at set 37°C (40% load)		6
time required to achieve 37°C of the load, at set 37°C (70% load)		10
energy cinsumption at 37°C [Wh/h]		66
temperature protection		class 3.1 to DIN 12880
power supply		230V 50-60Hz
sound levels [db(A)]		42
shelves (fitted./max.)		3/6
warranty		24 months
manufacturer		POL-EKO

all the above technical data refer to standard units (without optional accessories)

1) doesn't include rack for shelves space

2) depth doesn't include 50 mm of power cable

* - fluctuation measured in centre of chamber; in space, variation (K) calculated for chamber as: $K = \pm (T_{avg\ max} - T_{avg\ min}) / 2$

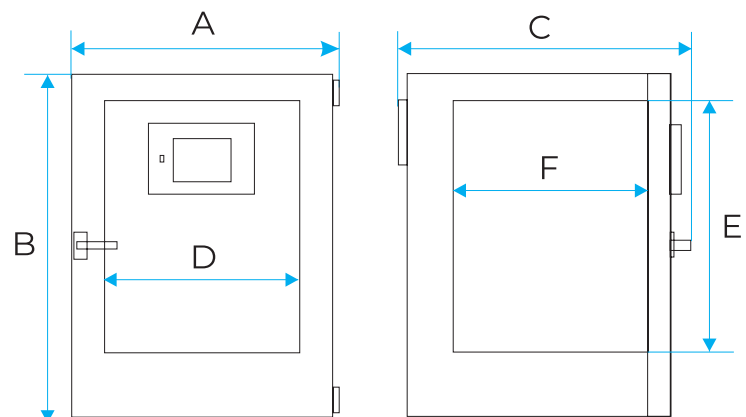

OPTIONS AND ACCESSORIES

(icon description see page 80-86)





CLIMATIC AND PHYTOTRON CHAMBERS

Climatic chambers with phytotron system can control temperature, humidity and light to create a stable environment



Climatic chamber KK 500 Smart PRO FIT DS



All thermostatic equipment manufactured by POL-EKO can be provided with Calibration Certificate issued by accredited Measurement Laboratory. Detailed information on accreditation is available on website: www.pol-eko.eu.

Quality control must be ensured during the whole production process. Final testing process can prove that all the required technical parameters have been met. Highest quality of our products has always been our top priority. Customers are obviously very demanding, as they require state-of-the-art equipment which is so important for their research. It is our passion and devotion to deliver a product we would recommend to ourselves.



STANDARD FEATURES

- temperature range: 0...+60°C (KK) and 0...+100°C (KKS), +10...+50°C (FIT option with light on)
- quality control protocol (at +25°C, 60%rH)
- English instruction manual
- temperature protection class 3.3 to DIN 12880
- open door alarm
- castors
- LAN and USB ports
- access port (Ø30 mm) on the left wall (at the back in FIT S/DS)
- automatic defrosting function
- deionized water container (for KK)
- door lock
- stainless steel wire shelves (INOX)
- double door (external solid, internal glass)
- Wi-Fi
- LAN cable
- LabDesk software

AVAILABLE VERSIONS

- Smart PRO
- KK with ultrasonic humidifier
- KKS with steam humidifier
- FIT phytotron

SOFTWARE

- LabDesk for downloading data to a computer (via LAN or Wi-Fi)

Application

- growth of plants and fungus
- seeds germination
- microorganisms and insects breeding
- photostability tests
- food preservation tests
- tests of building materials

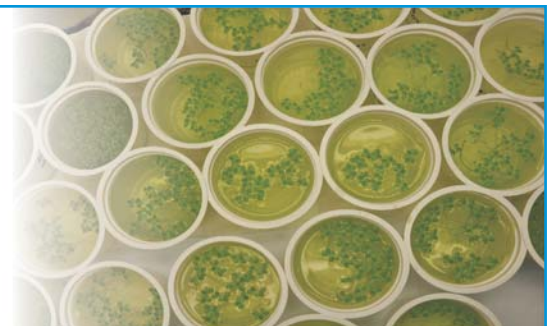

Climatic chambers with phytotron system (* /FIT option) except KKS models

- temperature, humidity and light control
- temperature range with light OFF: 0°C ... +60°C
- temperature range with light ON: +10°C ... +50°C
- light colour selection
- max light intensity 15000 lx per FIT P panel (measured 25 cm under the light source)
- day/night simulation with light intensity control
- fluorescent light tubes located in:
 - door and side walls
 - side walls
 - door
 - over-shelf panels
- LED modules located in:
 - over-shelf panels
 - side walls

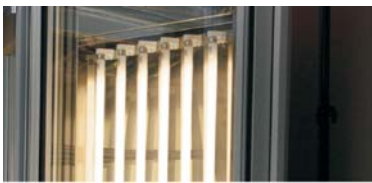

FIT D - light tubes installed in door

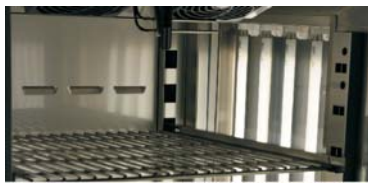

FIT S - light tubes installed in side walls



FIT DS - light tubes installed in door and side walls

Climatic chambers equipped with phytotron system can control temperature and humidity, as well as light intensity to simulate day and night conditions. Standard light colour is 840 type and the tubes can be installed in the door, side walls or over-shelf panels.

There are also special LED panels designed for plant growing. As most plants use only a part of the sunlight emission, narrow spectrum and specific colours have been used. A and B chlorophyll absorbance maxima are blue and red colour. Chlorophyll absorbs most energy and strongly influences photosynthesis at blue colour spectrum which intensifies growth. Hyper and far red colours stimulate blooming and proliferation.

	KK 115	KK 240	KK 350	KK 400	KK 500	KK 700	KK 750	KK 1200	KK 1450
FIT P	+	+		+	+	+	+	+	+
FIT D	+	+					+		
FIT S			+		+	+			
FIT DS			+		+	+			

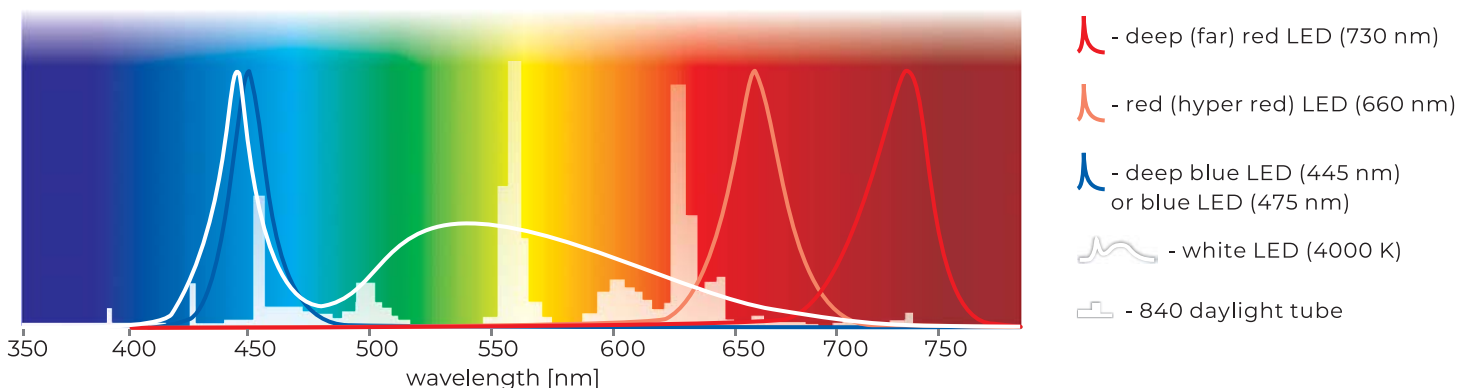

Climatic and phytotron chambers can be adapted to individual customer requirements. A wide range of additional equipment and the possibility of implementing non-standard solutions makes these units satisfy even the most demanding users.



Panel for **FIT P** version



Panel for **FIT P LED** version



Panel for **FIT P LED White** version

Available fluorescent light tubes

- standard type 840 for daylight simulation
- UV tubes for air sterilization and aging tests

Light intensity of a panel:

- FIT P type 840 ~280 $\mu\text{mol}/\text{m}^2\text{s}$
- FIT P LED white 4000 K ~800 $\mu\text{mol}/\text{m}^2\text{s}$ (25 cm distance from a shelf).

Available LED modules

- red (hyper red) – max for wavelength 660 nm
- deep blue – max for wavelength 445 nm
- blue – max for wavelength 475 nm
- deep (far) red – max for wavelength 730 nm
- white – colour temperature 4000 K

The dimmable over-shelf panels can be provided with several independently controlled colours of light. Other configurations on request.

FIT P version

Climatic chambers with over-shelf panels with light. Depending on the model, there can be between 1 and 3 panels inside the chamber (standard light colour: 840 daylight). The FIT P version includes 1 over-shelf panel and sockets to allow installation of extra panels if required (to be ordered separately).

The FIT/R3 option allows to control the light intensity separately for each panel.

	KK 115	KK 240	KK 400	KK 500	KK 700	KK 750	KK 1200	KK 1450
standard	1	1	1	1	1	1	1	1
max*	1	2	2	3	3	3	3	3
max light intensity on shelf [lx]	FIT version		5000	10000	15000	15000	15000	15000

*max number of over-shelf panels with illumination inside the chamber

FIT P LED version

The user can choose the light colour and intensity for each program segment. The colour modules can be combined, e.g. far red with blue. Dimming allows to set the required level of intensity. This flexibility provides specific light selection for each plant. The LED modules are long-life – after 25000 operating hours they still feature 90% of the nominal efficiency. The unique optics ensures uniform light distribution for each plant. The LED technology also emits very little heat which helps maintain precise temperature inside the chamber.

The FIT/R3 option allows independent control of each panel and/or each light colour.

Climatic chambers

Climatic chambers with an ultrasonic humidifier are professional and reliable equipment to guarantee stable and precise conditions. They can be used for seed germination, fungus and plant growing or food tests. Perfect climatic conditions allow you to perform stability tests of pharmaceuticals and cosmetics, as well as packaging and electronics.

The ultrasonic humidifier uses piezo-electric generators which convert electrical energy into mechanical vibrations energy. The generators are immersed in deionized water and smash it into very small drops which are consequently sprayed uniformly inside the chamber.











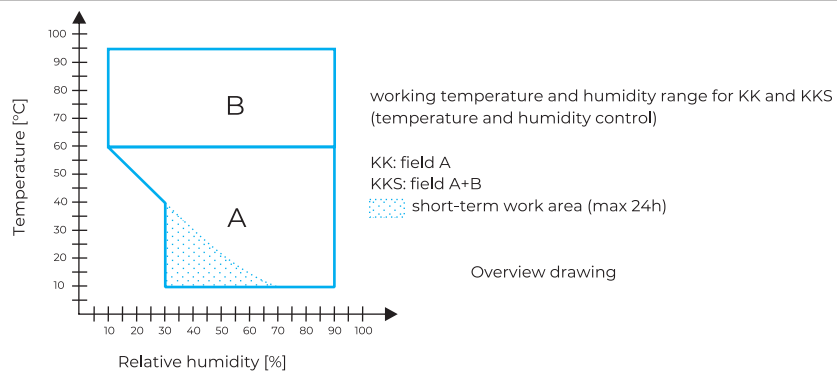

The **KKS climatic chambers** with a steam humidifier do not emit ultrasounds and therefore allow insects breeding (e.g. *Drosophila melanogaster*). Compared to the KK chambers, they feature an extended temperature and humidity range and can be used for tests of electronics, plastic or building materials.

The steam humidifier (steam generator) is a closed boiler that produces steam with higher pressure than atmospheric. The heat required to produce steam is obtained by a heater placed in a boiler. Much higher temperature and humidity range is used in more applications in comparison to KK units.

The KK and KKS climatic chambers can be used for pharmaceutical stability tests according to **ICH Q1A**.

Parameter		Climatic chamber KK with ultrasonic humidifier	Climatic chamber KKS with steam humidifier
temperature range	-	0°C... +60°C	0°C... +100°C
	FIT	0°C... +60°C (+10°C...+50°C with light on)	-
relative humidity range		field "A"	field "A+B"
water supply (conductivity)		deionized (<1 µS/cm)	tap water (125-1250 µS/cm)
water source		<ul style="list-style-type: none"> ■ deionized water container (included) ■ internal deionized water network ■ deionizer 	<ul style="list-style-type: none"> ■ water supply system
outflow		<ul style="list-style-type: none"> ■ drain system 	<ul style="list-style-type: none"> ■ drain system
power supply		<ul style="list-style-type: none"> ■ 230V 50-60Hz 	<ul style="list-style-type: none"> ■ 230V 50-60Hz ■ 400V 50-60Hz



		KK 115	KK 240	KK 350	KK 400	KK 500	KK 700	KK 750	KK 1200	KK 1450	
Parameter											
air convection		forced									
chamber capacity [l]		109	240	322	416	470	600	749	1330	1485	
working capacity [l]		109	240	283	416	392	485	749	1132	1264	
door type		double (external solid, internal glass) / external glass (option)									
temperature range [°C]	-	0...+60									
	FIT version	0...+60 (with light on +10...+50)									
temperature resolution [°C]		every 0,1									
relative humidity range [%]		30...90 (see working temperature and humidity chart for details on page 70)									
humidity resolution [%]		every 1									
controller		microprocessor PID with external 7" full colour touch screen									
interior		acid-proof stainless steel to DIN 1.4301									
housing	-	powder coated sheet									
	IG	stainless steel linen finish									
overall dims ¹ [mm]	A width	670	830	660	1030	660	750	1270	1480	1460	
	B height	1340	1600	2000	1850	1990	1990	2010	1990	1940	
	C depth	950	1010	990	1010	1080	1140	1120	1130	1240	
internal dims [mm]	D width	460	600	470	800	470	530	1040	1270	1270	
	D' width	-	-	510	-	510	600	-	1330	1340	
	E height	530	800	1340	1040	1510	1510	1200	1510	1460	
	F depth	440	500	500	500	600	650	600	650	750	
	I height	-	-	1180	-	1360	1350	-	1330	1270	
max shelf workload ² [kg]	-	10	10	10	10	20	30	-	30	30	
	PW ³ version	50	100	100	100	100	100	100	100	100	
max unit workload [kg]		60	90	100	120	100	150	140	300	300	
nominal power [W]		1350	1550	1850	2250	1850	1850	2850	3450	3450	
weight [kg]		90	170	125	185	130	170	275	220	230	
temperature variation* at +25°C iand 60%rH [±/- °C]		2,0	2,0	2,0	2,0	2,0	2,0	2,0	2,0	2,0	
relative humidity variation* at +25°C and 60%rH [±/- %rH]		5,0	5,0	5,0	5,0	5,0	5,0	5,0	5,0	5,0	
temperature protection		class 3.3 to DIN 12880									
power supply**		230 V 50-60Hz									
shelves fitted/max		2/7	3/10	3/11	3/14	3/11	3/11	5/16	2 x 3/11	2 x 3/11	
refrigerant		R1234ze / GWP=1					R290 / GWP=3				
warranty		24 months									
manufacturer		POL-EKO									

all the above technical data refer to standard units (without optional accessories)

* - variation (K) calculated for chamber as: $K = \pm / - (T_{avg\ max} - T_{avg\ min}) / 2$

** - other power supplies on request





1 - external dimensions for units without FIT option, depth doesn't include 50 mm of power cable

2 - on uniformly loaded surface

3 - reinforced shelf

OPTIONS AND ACCESSORIES (icon description see page 80-86)



		KKS 115	KKS 240	KKS 400	KKS 750
Parameter					
air convection		forced			
chamber capacity [l]		109	240	416	749
working capacity [l]		109	240	416	749
door type		double (external solid, internal glass) / external glass (option)			
temperature range [°C]		0...+100			
temperature resolution [°C]		every 0,1			
relative humidity range [%]		30..90 (see working temperature and humidity chart for details on page 70)			
humidity resolution [%]		every 1			
controller		microprocessor PID with external 7" full colour touch screen			
interior		acid-proof stainless steel to DIN 1.4301			
housing	-	powder coated sheet			
	IG	stainless steel linen finish			
overall dims ¹ [mm]	A width	670	830	1030	1270
	B height	1340	1600	1850	2010
	C' depth	820	880	880	990
internal dims [mm]	D width	460	600	800	1040
	E height	530	800	1040	1200
	F depth	440	500	500	600
max shelf workload ² [kg]	-	10	10	10	-
	PW ³ version	50	100	100	100
max unit workload [kg]		60	90	120	140
nominal power [W]		2900	3250	3650	4250
weight [kg]		122	140	185	275
temperature variation* at +25°C and 60%rH [±/°C]		2,0	2,0	2,0	2,0
relative humidity variation* at +25°C and 60%rH [±/ %rH]		5,0	5,0	5,0	5,0
temperature protection		class 3.3 to DIN 12880			
power supply**		230V 50-60Hz		400V 50-60Hz	
shelves fitted/max		2/7	3/10	3/14	5/16
refrigerant		R1234ze / GWP=1		R290 / GWP=3	
warranty		24 months			
manufacturer		POL-EKO			

all the above technical data refer to standard units (without optional accessories)

* - fluctuation measured in centre of chamber; in space, variation (K) calculated for chamber as: $K = \pm (T_{avg\ max} - T_{avg\ min}) / 2$

** - other power supplies on request

1 - external dimensions for units without FIT option, depth doesn't include 50 mm of power cable

2 - on uniformly loaded surface

3 - reinforced shelf

Reverse osmosis system included, external dimensions of the unit do not include the reverse osmosis system (14 kg).

OPTIONS AND ACCESSORIES (icon description see page 80-86)



■ Dimensions KK/KKS 115/240/400/750

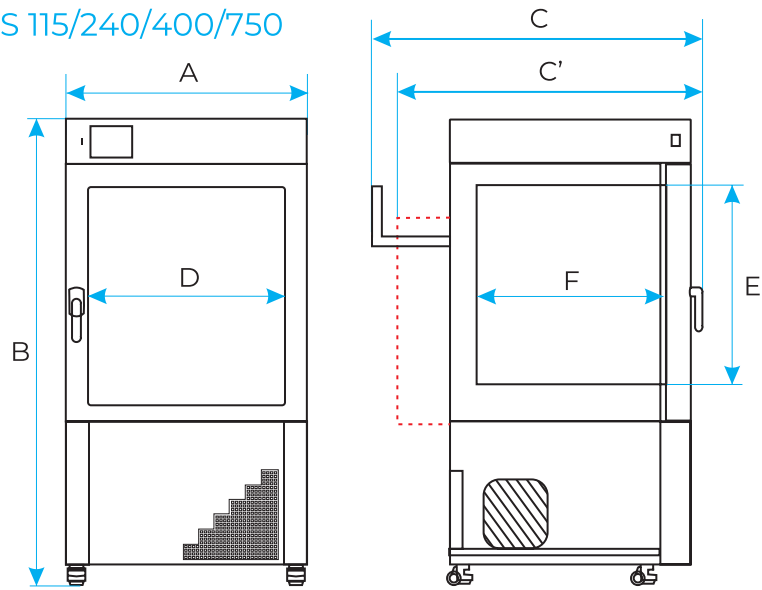

■ Dimensions KK 350

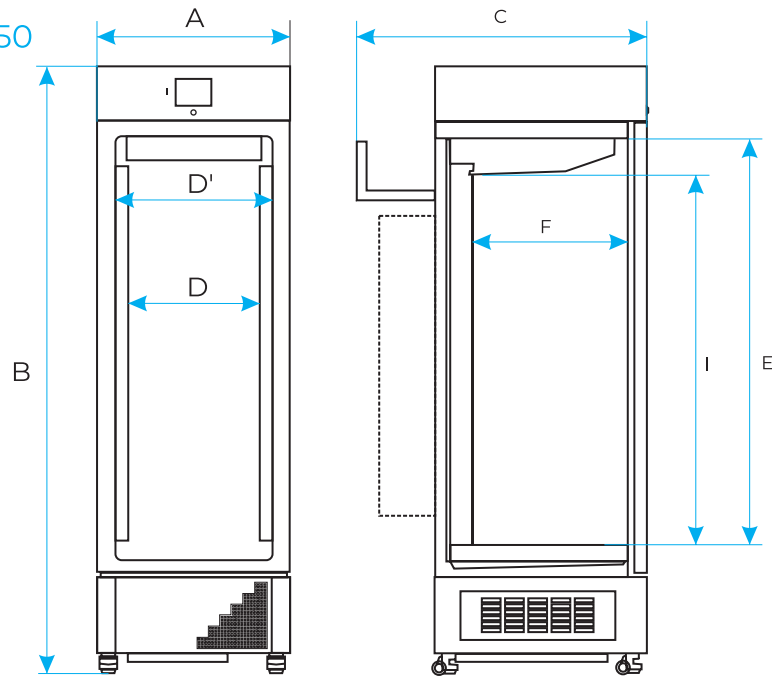

■ Dimensions KK 500/700/1200/1450

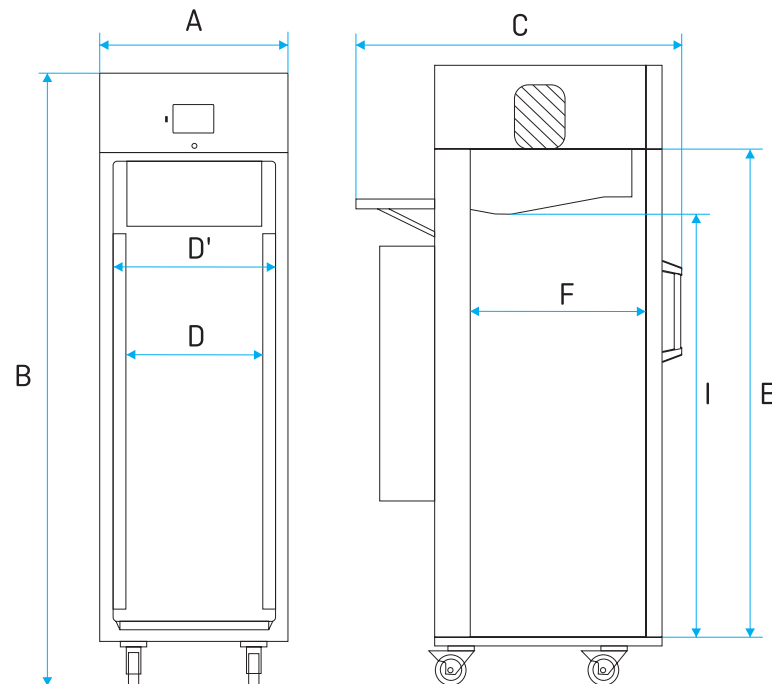

Dry-aging cabinets and chambers

They are a perfect solution for food and meat industry and can be used for ripening of all kinds of meat. The units have been equipped with a touch screen controller to allow precise temperature and humidity control for proper process conditions.

■ SD ripening cabinet

A 700-liter cabinet for maturing (ripening) of various types of meat. It has been equipped with a cooling and humidification system and features our brand-new SMART PRO controller. Perfect for commercial and industrial use.

Standard accessories

- temperature range from -1°C to ambient
- humidity control up to 90%
- steam humidifier
- active ventilation function
- fan speed control
- possibility to set up segments and ramps
- internal LED light (spectrum out of UV radiation)
- automatic defrosting
- forced manual defrosting option
- open door counter
- water level sensor
- 20L demineralized water container (option)
- condensate cuvette (option)
- stainless steel tray (option)
- hanger (option)

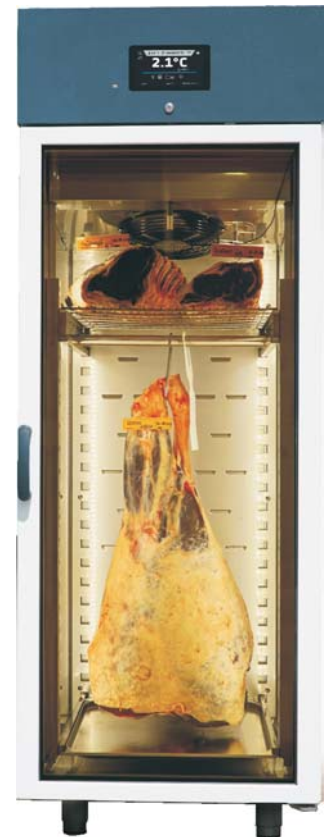

■ KD ripening chamber

They have been designed for ripening, storing and maturing meat. The construction allows uniform air circulation inside the chamber and perfect microclimate to suit ripening. The air inside the chamber comes through stainless steel ventilation ducts. Sterile and odourless steam is ensured by a pressure steam generator. A large and easy to use touch screen improves the user experience. Optional smoke generator provides extra flavour for meat products.

- temperature range 0 ...+20°C
- steam generator
- gravitational ventilation of chamber with manual control
- internal lighting
- automatic defrosting and condensate removal
- 20L demineralized water container
- water level sensor
- smoke generator (option)
- food trolleys with ramp (option)



OPTIONS AND ACCESSORIES



Internal glass door

This is standard equipment in CL/IL/KK ranges.
This is an additional option available for ST/CHL ranges.
Order number: */C (factory fitted).



External glass door

This is an additional option available for ST/CHL ranges and for KK 500, 700, 1200, 1450 models.
Order number: */A (factory fitted).
In case of ST models in Smart PRO version, maximum temperature is reduced to 40°C.



Door with viewing window

This is an additional option available for CL/IL/SL/SR ranges (except CL/SL 15, 32) and for KK 115, 240, 400, 750 models.
Order number: */A (factory fitted).
In case of SL range, maximum temperature is reduced to +250°C.

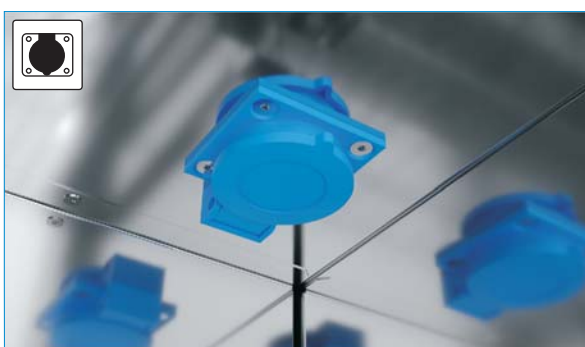

Internal socket

This is an additional option available for ST/CHL/CL/ILW ranges. In case of CL/ILW maximum temperature is reduced to +70°C.
Order number: GNZ (factory fitted).
Internal socket allows to plug in additional equipment inside the chamber, e.g. laboratory shaker.
Max socket peak load 200 W (max 3pcs).



Interior lighting

This is standard equipment in ST/CHL ranges.
This is an additional option available for ZL/ILW/CL/SL/SR ranges (except CL/SL 15, 32).
Order number: OWW/OWW LED (factory fitted).
Interior lighting features 1 light point. The user switches it on with enter button located in the front panel.
This option does not allow day/night simulation (see FIT and FOT options). Max working temperature of the unit is reduced to +70°C, for SL/SR ranges to +250°C and for ZL-T range to -35°C.

Wire shelf

This is standard equipment in ST/CHL B(basic) models.

Order number: */P.

Wire shelf is made of steel and covered with plastic. It is provided with slides.



Perforated shelf

This is standard equipment in ZLW-T models.

This is an additional option available for ST/CHL/ZL/CL/IL/SL/SR/KK ranges.

Order number: */PP.

Perforated shelf is made of stainless to DIN 1.4301 steel and provided with slides. Different depths of the shelf on request.

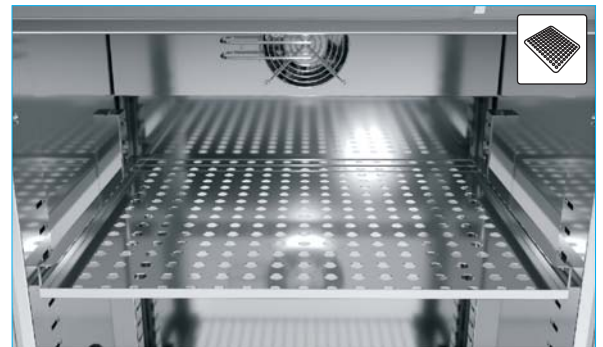

Full shelf with hole

This is standard equipment in ZLN-T models.

Order number: */PO.

Shelf is made of stainless steel and provided with slides.



Stainless steel wire shelf (INOX)

This is standard equipment in CL/IL/SL/SR/KK ranges, ZLN 85 model and in ST/CHL C (comfort) and P (premium) models.

Order number: */P INOX.

INOX wire shelf is made of stainless steel to DIN 1.4301 and provided with slides.



Reinforced shelf

This is standard equipment in CL/IL/SL/SR/KK 750 and 1000 models and all CL/ILW/SL models in the reinforced version

(order number: */W).

This is an additional option available for CL/ILW/SL/SR/ST/CHL/KK ranges and ZL-T models.

Order number: */PW.

Reinforced shelf can be wire, perforated or with a whole.

It is provided with slides.

Maximum shelf workloads and maximum unit workloads can be found in tables with parameters for certain product ranges.





Reinforced version

This is a standard feature of CL/SL/SR 1000 models. This is an additional option available for CL/ILW/SL ranges and ZL-T 125, 200, 300 models. **Order number: */W** (factory fitted). Reinforced version of products allows to store heavy loads in chamber. It consists of reinforced construction of the chamber and reinforced shelves. In this way we prevent damage to the unit caused by heavy loads. Maximum shelf workloads and maximum unit workloads can be found in the tables with parameters for certain product ranges. When a unit in reinforced version is purchased, the reinforced shelves are supplied instead of standard shelves.



Aluminum drawer with powder coated slides

This is an additional option available for ST/CHL ranges. **Order number: ST/CHL SWP ALU.** The drawer is aluminum, 6 cm deep, provided with a pull out powder coated slides set, with 2 compartments longways + 2 across in each section.

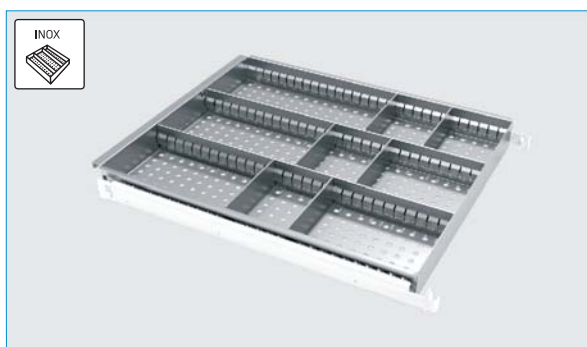

Stainless steel drawer with powder coated slides

This is an additional option available for ST/CHL ranges. **Order number: ST/CHL SWP INOX.** The drawer is stainless steel, 6 cm deep, provided with pull out powder coated slides set, with 2 compartments longways + 2 across in each section.

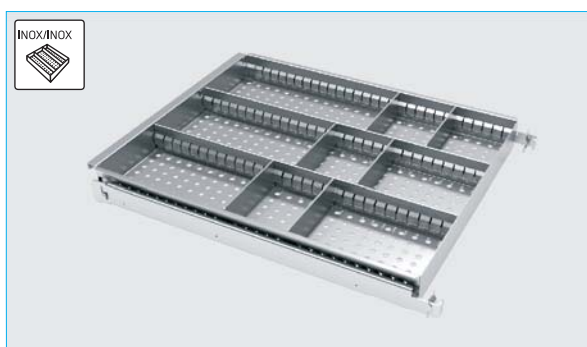

Stainless steel drawer with stainless steel slides

This is an additional option available for ST/CHL ranges. **Order number: ST/CHL SWPN INOX.** The drawer is stainless steel, 6 cm deep, provided with pull out stainless steel slides set, with 2 compartments longways + 2 across in each section.



Pharma organizer

This is an additional option for ST/CHL 2/3/4/5/6. Consists of 4 drawers. **Order number: ORG-FARM.**

Stainless steel cuvettes

This is an additional option available for all products ranges.

Order number: KUW.GN */*

Stainless steel cuvettes can be placed on the shelves.

Different sizes available.



Photoperiodic system

This is an additional option for ST and ILW in Smart version

Order number: */FOT (factory fitted).

Photoperiodic system allows day and night simulation.

See page 44 for more details.



Phytotron system

This is an additional option for the KK range, ILW Smart PRO version and ST 500-1450 Smart PRO models.

Order number: */FIT (factory fitted).

Phytotron system allows day and night simulation with smooth illumination control (each 1%).

See pages 45/ 68-69 for more details.

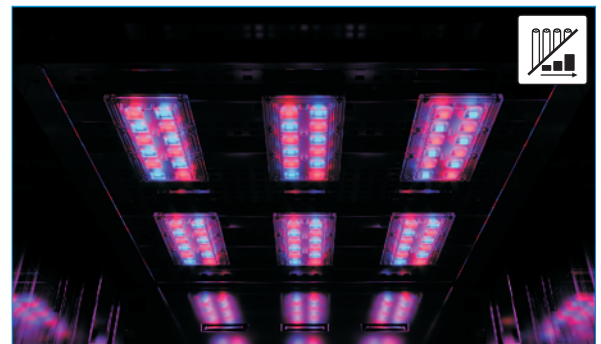

Additional Pt 100 temperature sensor

This is an additional option available only for SMART PRO version units (except for KK/KKS and units equipped with automatic defrosting function -PLUS or FOT/FIT option).

Order number: Pt 100 (factory fitted).

This option consists of an additional temperature sensor and a sensor's socket. The additional temperature values can be shown in the display. The user can set the main and additional sensor. This way unit can work according to the sample temperature in which additional Pt 100 sensor is placed.

The sensor may be supplied with a calibration certificate.



Castors

This is a standard equipment in ST/CHL 1200, 1450, CL/IL/SL/SR 400, 750, 1000, ILW 240 and KK/ZL-T, ZLN-UT ranges.

This is an additional option available for all product ranges.

Order number: QLK*(factory fitted).

Large size units have been equipped with castors as standard to facilitate transport. For other units castors can be fitted on request.





Container for deionized water

This is standard equipment in KK range (except KKS). This is an additional option available for KK range.

Order number: KK/Z.

This plastic container is for deionized water which is indispensable for a proper KK performance.

The container is not necessary in case the chamber is plugged directly to a deionizer.



Chart recorder

This is an additional option available for ST/CHL 500, 700, 1200, 1450 models.

Order number: */RK (factory fitted).

The built in chart recorder with constant temperature registration is equipped with a battery back-up, therefore it keeps temperature registration even in case of power shortage. It comes with 100 pieces of registration papers as a start kit.



Magnetic door lock

This is an additional option available for ST/CHL 500, 700, 1200, 1450 models.

Order number: */ZKM (factory fitted).

The magnetic door lock comes with the set of access cards – 5 pcs. RFID card reader enables quick access to the chamber (the reader must be touched with the card in order to open the door). The access is reserved only for authorized users (card holders).

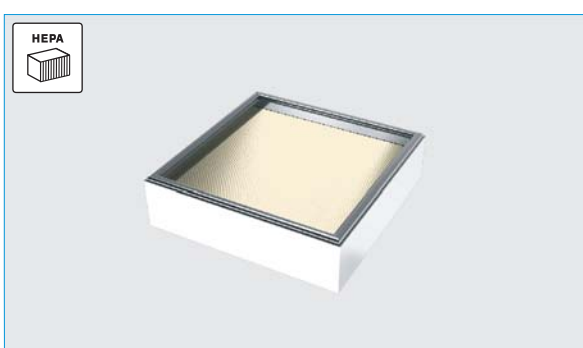

HEPA-fresh air filter

This is an additional option available for CL/SL/SR ranges.

Order number: HEPA (factory fitted).

HEPA filter is installed at the air inlet to the chamber



Table on castors

This is an additional option available for ST/CHL 1-3, ZLN 85, CL/SL 15, 32, CL/IL/SL/SR 53-240 models.

Order number: */S (powder painted) or ***/S INOX** (stainless steel).

Table with castors provides you with the highest comfort of using our products. We offer a wide range of tables equipped with castors. Different sizes of the tables are available on request.

The user can choose the most suitable height.



FIT panels independent control

This is an additional option available for the units equipped with FIT option – at least two (2) over-shelf illumination panels. Possibility of independent over-shelf lighting control.

Order number: FIT/R3 (factory fitted).

It allows to control the light intensity independently for each of 2 or 3 over-shelf panels (e.g. the light intensity above one of the shelves can be set to 100%, and above the other to 50%).



Extended temperature range ST/70

This is a standard feature of ST Smart Pro models. This is an additional option available for ST models with solid door.

Order number: ST/70 (factory fitted).

This is an extended temperature range up to +70°C (standard temperature range in ST models is +3°C...+40°C).



Calibration of the chamber

This is an additional option available for all product ranges. **Order numbers: BRT/9/L, BRT/1P/L, BRT/2P/L, IQ, OQ, PQ.** Measurements are performed at 9 points of the chamber (corners + geometric center) or at 5 points on the shelf (corners + geometric center) at the temperature selected by the user. Moreover, IQ, OQ, PQ complete qualification procedure are available for each unit (see page 117).



Low temperature version

This is an additional option available for ILW range.

Order number: *T (factory fitted).

It extends temperature range down to -10°C (standard temperature range starts from 0°C).



Non-standard access port

This is an additional option available for all product ranges. **Order number: OCZ/20, OCZ/30, OCZ/60, OCZ/100** (factory fitted). The orifice is made in addition to the standard access port. Available diameters: 20 mm, 30 mm, 60 mm, 100 mm. The diameter of the orifice and its location must be agreed with the manufacturer before placing an order.



Alarm port – signaling (NC-NO)

This is an additional option available for all product ranges (except SL SIMPLE and CALDERA).

Order number: PORT ALARM (factory fitted)

Potential-free alarm contacts are intended to inform the user about the unit's state. They can be connected to external monitoring with digital/binary input. The alarm port is a relay-type output with NC-NO contacts. The contacts are switched when there is a power outage or an alarm occurs. Circuit close (COM-NO): unit is on and works properly. Circuit open (COM-NO): unit is off or some malfunctions occurred.



Automatic defrosting function

This is a standard feature for KK and ST/ILW models with FOT and FIT illumination. This is an additional option available for ST/CHL/ILW models.

Order number: * PLUS (factory fitted).

The automatic defrosting function is performed while the unit is running. Used technology causes only a slight increase in temperature in the chamber (slight peak). Default settings - 2 minutes defrosting every 2 hours, causes a temporary increase in temperature in the chamber by approx. 3°C. Defrosting parameters can be changed by the User depending on the application - test type (wet / dry), door opening frequency, etc.



CO₂ back up system

This is an additional option available for ZLN-UT range.

Order number: ZLN-UT/CO2 (factory fitted).

Enables the freezer controller to dose CO₂ in case of undesired temperature increase in the chamber. It is supplied with an internal battery. This solution is particularly recommended in the event of a power outage.



ZLN-UT/ST rack with drawers

This is an additional option available for ZLN-UT range.

Order numbers: ZLN-UT/ST12, ZLN-UT/ST16

Sturdy and heavy duty, made of stainless steel; feature quick and easy access to all boxes; 3 or 4 drawers (each for 4 boxes) per rack.



Boxes

This is an additional option available for ZLN-UT range.

Order number: ZLN-UT/STP12 ZLN-UT/STP16

Boxes set (12 or 16) made of polypropylene (dimensions 133x133x50mm; each box suits 81 test-tubes of Ø 12,5mm) or made of cardboard.



Display battery backup 12h

This is a standard feature for ZLN-UT range.

This is an additional option available for all product ranges (except SL SIMPLE and CALDERA).

Order number: BPP 12 (factory fitted).

Battery backup for display up to 12 h (only data registration, no parameters control)



Low water level sensor

This is an additional option available for KK range (except KKS).

Order number: KK/CP (factory fitted).

An alarm goes off when the water level is low.

Defrosting function

This is a standard feature for CHL models without automatic defrosting function. Defrosting is performed automatically but it has to be launched manually by the user at the most suitable time (e.g. when there are no samples in the chamber). Defrosting involves temporary heating inside the chamber by approx. 20-30°C. Therefore it can't be implemented during its operation (to not disturb temperature fluctuation).

Over/under temperature (and humidity in KK/KKS) alarm

In the menu, you can set the permissible value of exceeding the set temperature (and humidity in KK/KKS). If the temperature or humidity in the chamber rises beyond the acceptable limit, an audible alarm will sound and the ALARM icon will appear on the display.

Temperature (and humidity in KK/KKS) sensor fail alarm

When the temperature (and/or humidity in KK/KKS) sensor does not work properly, the display shows information about the error.

E-mail reports

This is a standard feature of all units in Smart PRO version. This feature involves sending e-mail messages (up to 3 addresses) in the event of alarms, events in the program or events related to editing users. The function can be configured according to individual requirements. The condition for sending the message is connection to the Ethernet network.

Ethernet connection and remote control via Internet

This is a standard feature for Smart and Smart PRO models. Each unit can be connected to the Ethernet network or directly to the computer with a LAN cable (optional for Smart and standard for Smart PRO). LabDesk software (optional for Smart and standard for Smart PRO) is needed to read data (saved data and event log). With this feature, equipment can be controlled and monitored via Internet. It is also possible to connect several units at the same time and control them from one computer.

Measurement data memory

All the units (except SL SIMPLE) are equipped with the measurement data memory function as standard. It allows you to store 10,000 measurement results which are stored in the memory of Smart units for 6 months, and in Smart PRO for 12 months. You can download them to USB flash drive or transfer them to your computer at any time. The data can be opened in LabDesk or MS Excel.

Standard access port for external sensor

All the units are equipped with a standard access port. It is placed in the left side of the chamber (in case of SL SIMPLE – in the right). Access port which has been secured with a silicone plug can be used to insert an external temperature sensor.

Open door alarm

All units (except SL SIMPLE) are equipped with an open door alarm. Upon opening the door the alarm goes off (sound alarm and message appears on the display) according to the set by the user alarm delay.

Wi-Fi communication

Equipment with Smart PRO controllers are equipped with a Wi-Fi communication module. It enables wireless communication and data transfer to LabDesk software.

Door lock

All the units (except SL SIMPLE) are equipped with the door lock.

Parameters priority

Equipment which features parameters priority works according to the following rule: the unit achieves set parameter first (temperature, humidity) and then starts time countdown. In this case the set parameter is important.

Time priority

Equipment operating with time priority operates according to the following principle: the unit simultaneously starts counting the time and the process of achieving the set parameters. Time is the main parameter in this case.

Power failure control

A temporary power failure during program operation would be unnoticeable to the user, as the program continues after power is restored. Therefore, if a power failure occurs while a program is running, a message appears in the display. The information also appears in the event log.

Administrator function

This is a standard feature for all devices in Smart PRO version. It allows to manage user accounts and supports GLP.

Schedules

It's possible to schedule programs for all units in Smart PRO version. This feature allows you to create a list of programs to be run at the set time. Several different schedules can be created.

USB port

All the units (except SL SIMPLE and CALDERA) are equipped with a USB port. It's used to transfer data from the internal memory of the unit to the flash memory. The data saved in the *.csv file can be opened in Notepad. Data saved as *.plx can be opened in LabDesk.

Audible alarm

This function activates an audible alarm at a time specified by the user.

Temperature (and humidity in KK/KKS) calibration

Each equipment is calibrated by the manufacturer in accordance with applicable standards. The temperature displayed corresponds with high accuracy to the temperature in the geometric center of the chamber. User calibration is not necessary for the correct operation of the unit. However, the user has the option of calibrating the chamber (Smart and Smart PRO) on his own responsibility and must be aware of the consequences of changing the factory parameters of the equipment. If the unit has been calibrated, the calibration certificate becomes invalid after the new correction is made.

Fan speed control

This is a standard feature for SL/CL/ILW/KK Smart, Smart PRO and ST/CHL 1-6 Smart PRO. It allows you to control the fan speed in the range 0/10/50 ... 100% (depending on the model). Different fan speed can be set for each program separately.

Over temperature protection class 1.0 and class 2.0 according to DIN 12880

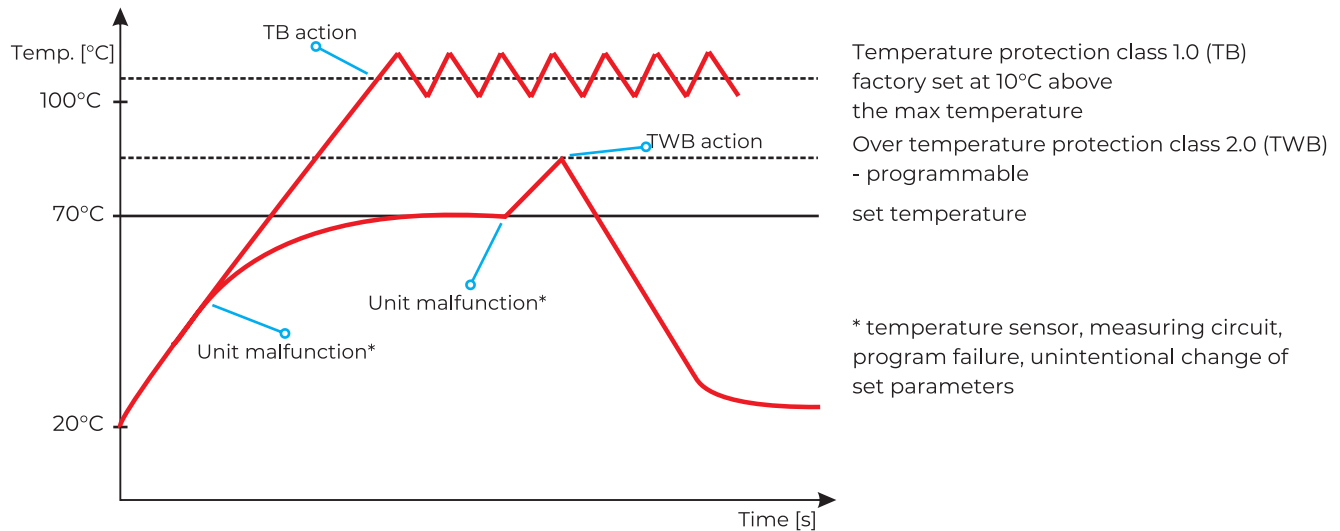

Over temperature protection class 1.0 to DIN 12880 is a standard function for the ST/CHL/CL/IL/SL/SR/KK/CALDERA and SIMPLE equipment. It is factory set at approx. 10°C above the max temperature. Over temperature protection class 2.0 to DIN 12880 is a standard function for the CL/IL/SL/SR equipment in the Smart version.

It features a sample protection function: the user can set the protection temperature and once it has been exceeded, the program will cut off the heaters. To resume operation, the user has to switch the unit off and turn it on again

DIN
3.1

Over temperature protection class 3.1 according to DIN 12880

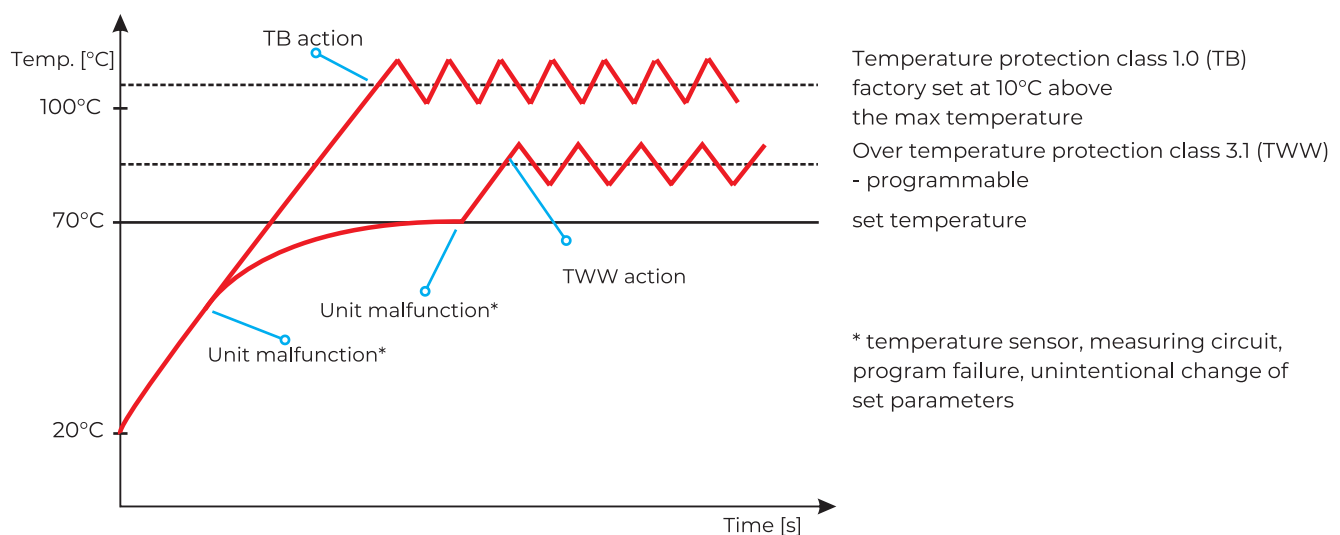

Over temperature protection class 3.1 to DIN 12880 is a standard function for the CL/SL and CALDERA equipment in the Smart PRO version, and optional for the CL/SL/SR ranges in the Smart version.

Order number: */3.1 (factory fitted).

It features a sample protection function: the user can set the protection temperature and once it has been exceeded, the program will cut off the heaters. When the temperature falls down below the set limit, the unit will resume operation automatically.

DIN 3.2

Under temperature protection class 3.2 according to DIN 12880

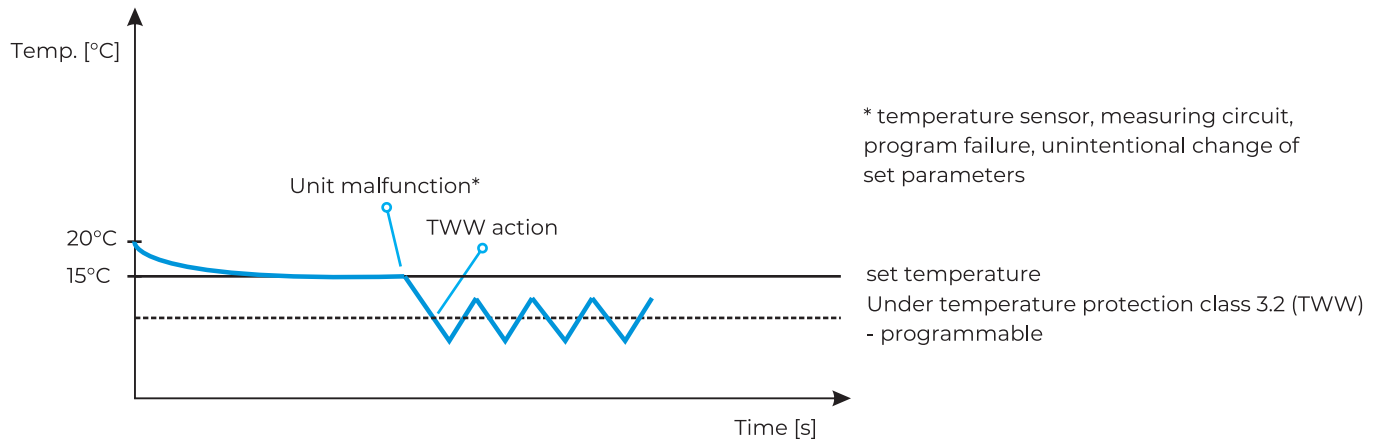

Under temperature protection class 3.2 to DIN 12880 is a standard function for CHL Smart PRO version and optional for CHL in Smart version.

Order number: */3.2 (factory fitted).

It features a sample protection function: the user can set the protection temperature and once it has been exceeded, the program will cut off the compressor. When the temperature goes above the set limit, the unit will resume operation automatically.

DIN 3.3

Over/under temperature protection class 3.3 according to DIN 12880

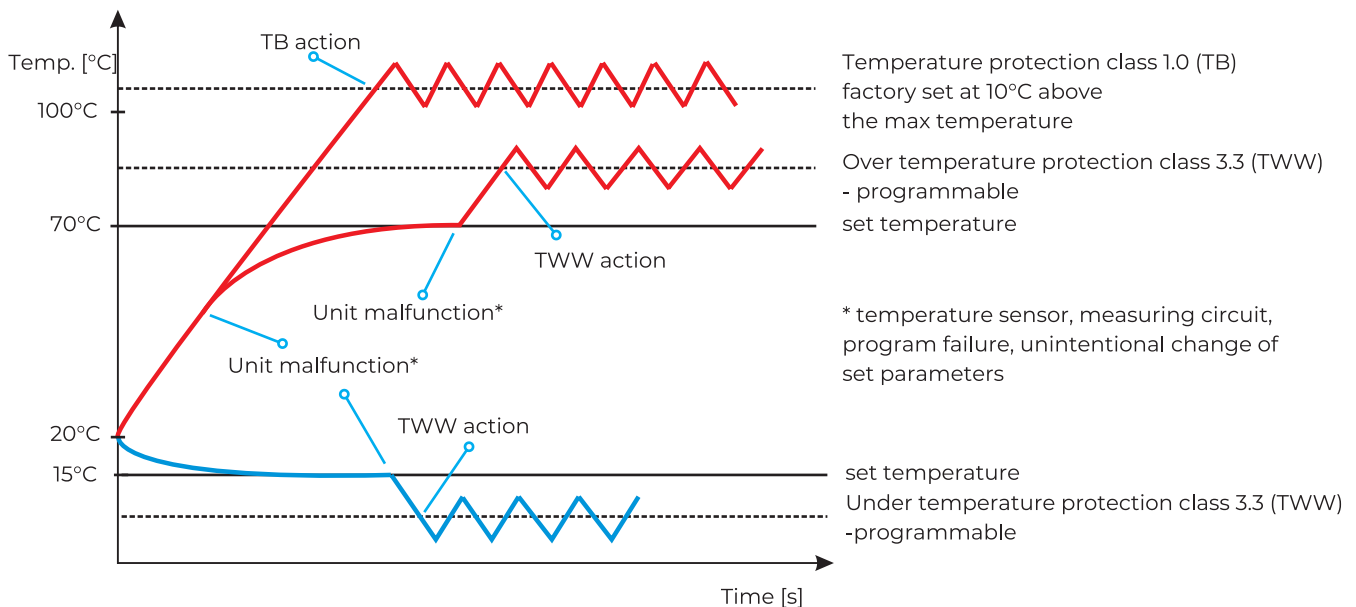

Over/under temperature protection class 3.3 to DIN 12880 is a standard function for the KK, ST and IL in the Smart PRO version. It is an additional option for ST and IL in the Smart version.

Order number: */3.3 (factory fitted).

It features a sample protection function: the user can set the over/under protection temperature and once it has been exceeded, the program will cut off the heaters or the compressor. When the temperature goes back to the permitted range, the unit will resume operation automatically.

■ All POL-EKO Smart and Smart PRO units can be connected to the Ethernet network and monitored remotely using the LabDesk application. The software also enables remote control of the Smart PRO models.



■ The application has the following functionalities

- simultaneously connect several Smart PRO units
- control units remotely
- overview of current temperature (and humidity)
- overview of running program status
- alarm information
- download registered data / events
- generate reports
- produce charts



■ Main features

	Smart	Smart PRO
dongle required	Yes	No
control unit remotely	No	Yes
monitor unit remotely	Yes	Yes
max number of connected units	10	infinity
save real-time running program data to the file	No	Yes
option to create programs and upload them remotely	No	Yes
start / stop programs	No	Yes
modify existing programs	No	Yes
create programs offline	No	Yes
set a delayed start for a program	No	Yes
overview of current data statistics	Yes	Yes
generate reports from current statistics	Yes	Yes
generate reports/ charts from registry or events data file	Yes	Yes
option to create schedules and upload them remotely	No	Yes
open registry data file / events downloaded from the unit	Yes	Yes
user management panel	Yes	Yes
change time zone	No	Yes
unit interface settings	No	Yes
change temperature correction	No	Yes
set alarms	No	Yes
edit users	No	Yes



LABORATORY EQUIPMENT

RT 2014 data logger

■ The new generation of RT data loggers enables continuous measurement of temperature and/or humidity values in thermostatic equipment (thermostatic chambers, incubators, refrigerators, freezers, etc...), as well as in the ambient. In case of temperature increase beyond acceptable range (set by the user) or in case of power failures, the RT 2014 logger can send SMS notifications to selected phone numbers.

The following notifications are available:

- high/low temperature/humidity alarm, alarm notification delay
- 230V power shortage alarm, alarm notification delay
- automatic SMS reports at certain time of the day or on request

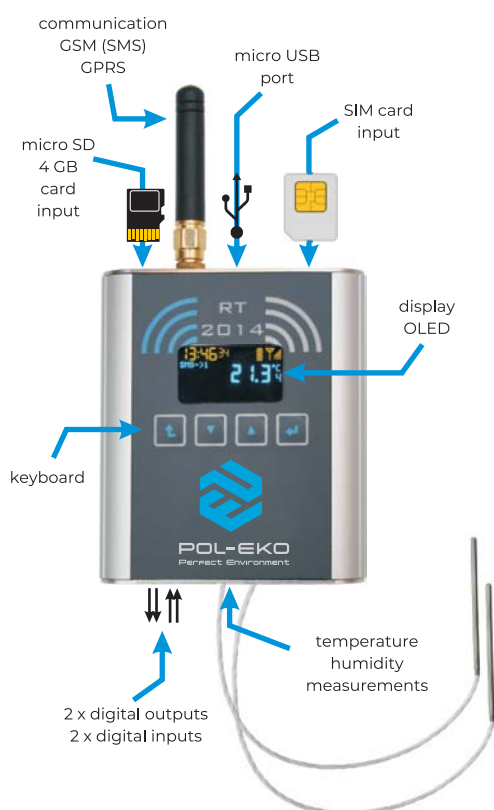

Data loggers

RT 2014_1T - temperature or humidity data logger with GSM, single channel model dedicated to temperature or humidity measurements in thermostatic chamber (single channel for one Pt 100 sensor or for one humidity sensor); internal memory (stored data can be downloaded to a PC with LabDesk software); GSM (sends SMS alarms for 5 phone numbers).

RT 2014_2T - temperature and/or humidity data logger with GSM module, double channel model dedicated to temperature and/or humidity measurements in thermostatic chamber (double channel for two Pt 100 sensors or one Pt 100 and one humidity sensor); internal memory (stored data can be downloaded to a PC with LabDesk software); GSM (sends SMS alarms for 5 phone numbers).

Service department is key to our company. We are aware that despite the huge effort and reliability of the entire team, equipment may fail occasionally. This is we address every single issue reported by our customers with highest attention and care. By eliminating errors we can prevent possible failures in the future and this is our greatest satisfaction. This allows further growth and development of the company.



RT 2014
GSM

Parameter		
temperature measurement		external Pt 100
temperature measurement range (according to sensor) [°C]		-110 ... +400 (depending on sensor type)
resolution of temperature measurement (-40...+200°C) [°C]		0,1
accuracy of temperature measurement (-40...+200°C) [°C]		+/- 0,5
humidity measurement		external RH_STD / RH_PREM
humidity measurement range [%]		RH_STD: 0-80, RH_PREM: 0-100
resolution of humidity measurement [%]		1%
accuracy of humidity measurement [%]		RH_STD: 1,8, RH_PREM: 0,8
length of sensors cables [m]		2,5
real time clock		yes
data record interval [min]		1/5/15/30/60
internal memory		1 mln data records
additional (external) memory		microSD 4 GB card
interface		micro USB
power supply		5 VDC via USB port
display		OLED 128x64 px
overall dims [mm]	A width	72
	B height	85
	C depth	20
weight [g]		165
battery operating time		up to 40 hours
GSM frequency [MHz]		850/900/1800/1900
quantity of phone numbers for SMS notification		5
warranty		24 months
manufacturer		POL-EKO

The RT 2014 data logger can be configured in the Avia application installed on your PC .

The recorded data can be accessed by:

- connecting the data logger to a PC
- using the microSD card

The RT 2014 GSM data logger can send text/sound alarms to max 5 mobile phone numbers.

There is a possibility to check the recorder status by dialling the data logger SIM number.

The RT 2014 will text the current parameters back.

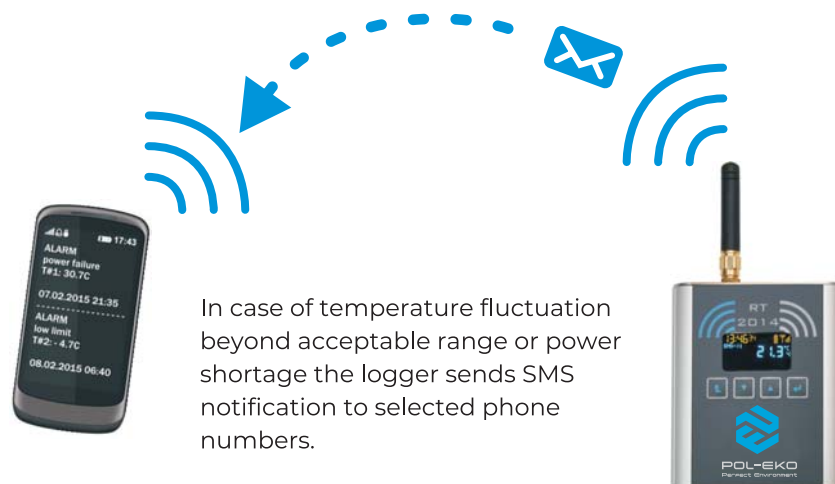
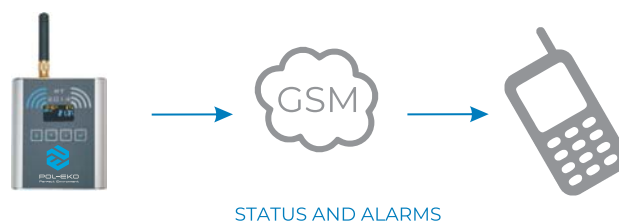
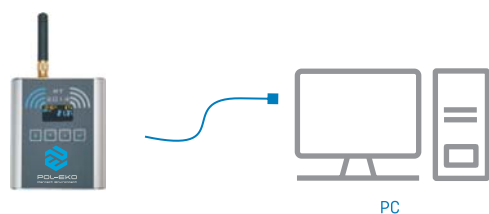

In case of temperature fluctuation beyond acceptable range or power shortage the logger sends SMS notification to selected phone numbers.

Accessories

Model	Photo	Description	Measuring range	Cable length
PT 100 H		temperature sensor for RT 2014 data logger, for high temperatures (recommended for CL/SL)	temp.: 0...+400°C	2,5 m
PT 100 S		standard temperature sensor for RT 2014 data logger (recommended for ST/CHL/IL/KK)	temp.: -40...+180°C	2,5 m
PT 100 L		temperature sensor for RT 2014 data logger, for low temperatures (recommended for ZL, ZLN-UT)	temp.: -110...+120°C	2,5 m
RH_STD		humidity and temperature sensor for RT 2014 data logger (recommended for ST/IL)	rH: 0...80% temp.: 0...+60°C	2,5 m
RH_PREM		humidity and temperature sensor for RT 2014 data logger (recommended for KK)	rH: 0...100% temp.: -50...+100°C	2,5 m
FIT		fitting	-	-
IN	-	binary inputs DIN1, DIN2 – potential-free contacts	DIN1, DIN2	2,0 m
OUT	-	binary outputs DOUT1, DOUT2 – transistor outputs max load 24 VDC 50 mA	DOUT1, DOUT2	2,0 m

Colony counter

Advantages

- automatic weight compensation of Petri plates
- anti-shock counting technology
- ringlight technology enables even illumination of the counting field
- bright or dark background selection
- mean value calculation function
- standard marker included
- Petri plates adapters (diameter < 120 mm)
- removable Wolfhugel counting plate
- adjustable push force
- sound and visual counting control
- adjustable position of the magnifying glass
- affordable price

Standard features

- colony counter
- magnifying glass
- standard marker
- bright and dark background
- Petri plates adapters
- Wolfhugel scale plate

Accessories

- marker ZM 2002 for external counting



Colony counter is invaluable help in every microbiological laboratory since the most time consuming activity is counting the colonies on Petri plates. An easy-to-use unit featuring quick and precise counting.

LKB 2002



Parameter		
counting field diameter [mm]		120
display		LED (0..999)
magnifying glass		2,5-X
illumination		20 W ringlight
dims [mm]	width	300
	height (without magnifying glass)	90
	depth	325
weight [kg]		4,9
nominal power [W]		22
power supply		230 V 50-60 Hz
warranty		24 months
manufacturer		POL-EKO

Laboratory shakers

Advantages

- orbital movement
- microprocessor control of rotation and time
- orbital diameter: 10...25 mm
- max load: 10 kg
- variable speed control: 30...500 rpm
- shaking mode: from 1 min to 99 h, or continuous operation
- LCD digital display
- anti-skid mat (option)
- various shaking tables
- can be located inside cooled incubators

Accessories

- universal shaking table
- separating funnel attachment
- platform for Petri plates
- fixing clip support
- dish attachment
- test tube support
- Erlenmeyer flasks (25...2000 ml) attachment
- anti-skid mat

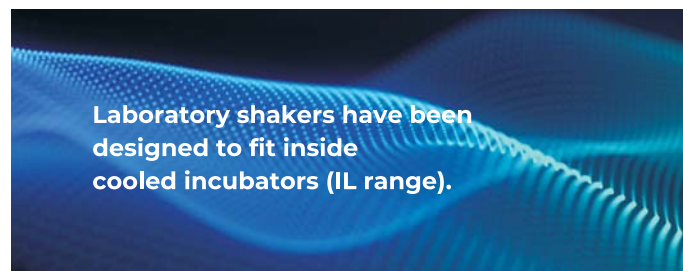

LS 280

LS 350

LS 500

LS 700



Parameter		LS 280	LS 350	LS 500	LS 700
movement		orbital			
controller		microprocessor			
display		LCD display			
speed range [rpm]		30 ... 500		30 ... 300	
accuracy [rpm]		10			
amplitude [mm]		5	5 or 12,5 (optional when placing an order)		
max load capacity [kg]		10			
shaking mode		1min ... 99h or continuous operation			
dimensions without / with shaking table [mm]	width	320	390	550	700
	height	120 / 220	120 / 220	120 / 220	120 / 220
	depth	330	400	440	420
fits to cooled incubator		ILW 53	ILW 115	ILW 240	ILW 400
nominal power [W]		60			
weight with shaking table [kg]		10	15	22	25
ambient temperature [°C]		+10...+40			
humidity [%]		up to 70			
voltage		230 V 50-60 Hz			
warranty		24 months			
manufacturer		POL-EKO			



Universal platform

Universal platform for various kinds of vessels with 4 roller clamps (without anti-skid mat).



Platform for fixing flasks handles

Platform for fixing flasks handles, suitable for flasks of the following capacities: 25ml, 50ml, 100ml, 250ml, 500ml, 2000ml, the handles shall be ordered separately.



Platform for Petri plates shaking

Platform for shaking Petri plates, bacteria culture flasks and other vessels of low centre of gravity.



Platform for separatory funnels

Platform for separatory funnels with 3 roller clamps for shaking, salting, extraction and concentration.

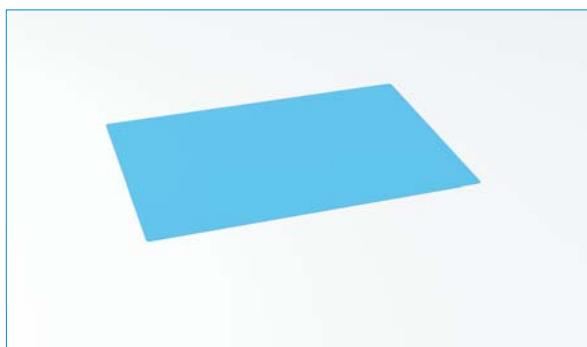

Anti-skid mat

Anti-skid mat for LS laboratory shakers.

Stationary samplers

Advantages

- sampling system:
 - vacuum
 - peristaltic pump
- sampling mode:
 - time proportional
 - flow proportional
 - event (e.g.: pH value exceeding)
 - combined
- intuitive menu
- up to 5 configurable sampling programs
- bottle filling overview
- suitable for continuous outdoor use
- can be implemented into a monitoring system
- refrigerated chamber
- SD card recording system: pH, conductivity, redox, dissolved oxygen, flow, chamber temperature etc.
- Sampler Viewer Application to download data from SD



PP 2002+

PP 2002E

PP 2002M



Representative sample taking according to PN-ISO 5667 directive.

Parameter	PP 2002+	PP 2002E	PP 2002M
sampling system	vacuum system	peristaltic pump	peristaltic pump / vacuum system
sample storing	stable temperature +4°C regardless of ambient conditions		
menu language	EN, FR, PL, CZ, RO, LT, IT		
medium	liquids of conductivity min 20 µS/cm and max temp. 60°C		
hose blowing	before and after sample taking		
sampling mode	automatic time proportional, flow proportional, event or manual		
sampling height [m]	max 8		
sample volume [ml]	regulated 30...250/500 (option of measuring vessel rinsing)	regulated 10...9990	regulated 30...250/500 or 10...9990
hose length [m]	8 standard		
hose diameter [mm]	12/13		
distributor	round		
number of bottles x capacity [l]	24 x 1; 12 x 2,9; 4 x 10; 1 x 25		
overall dims [mm]	width	630	630
	height	1070	1325
	depth	660	660
weight [kg]	90		100
housing	acid-proof stainless steel with 40 mm insulation		
ambient temperature [°C]	-20...+45		
nominal power [W]	450		550
controller	microprocessor, graphic display with contrast control, bottle filling overview		
programming	5 programs, 8 tasks each		
data logging	SD card + Sampler Viewer software		
input signals	8 analogue, 4 binary		
output signals	4 binary		
communication	RS 232 or RS 485		
installation site	indoor or outdoor		
power supply	230 V 50-60 Hz		
warranty	24 months		
manufacturer	POL-EKO		



Compact Line FUME HOODS

Compact Line fume hoods ensure safe and comfortable work in the laboratory. Metal construction and a wide range of finishing elements (worktops, internal chamber materials, sinks and fittings, etc.) allow the fume hood to be adapted to the needs of any laboratory. Designed according to PN-EN 14175.

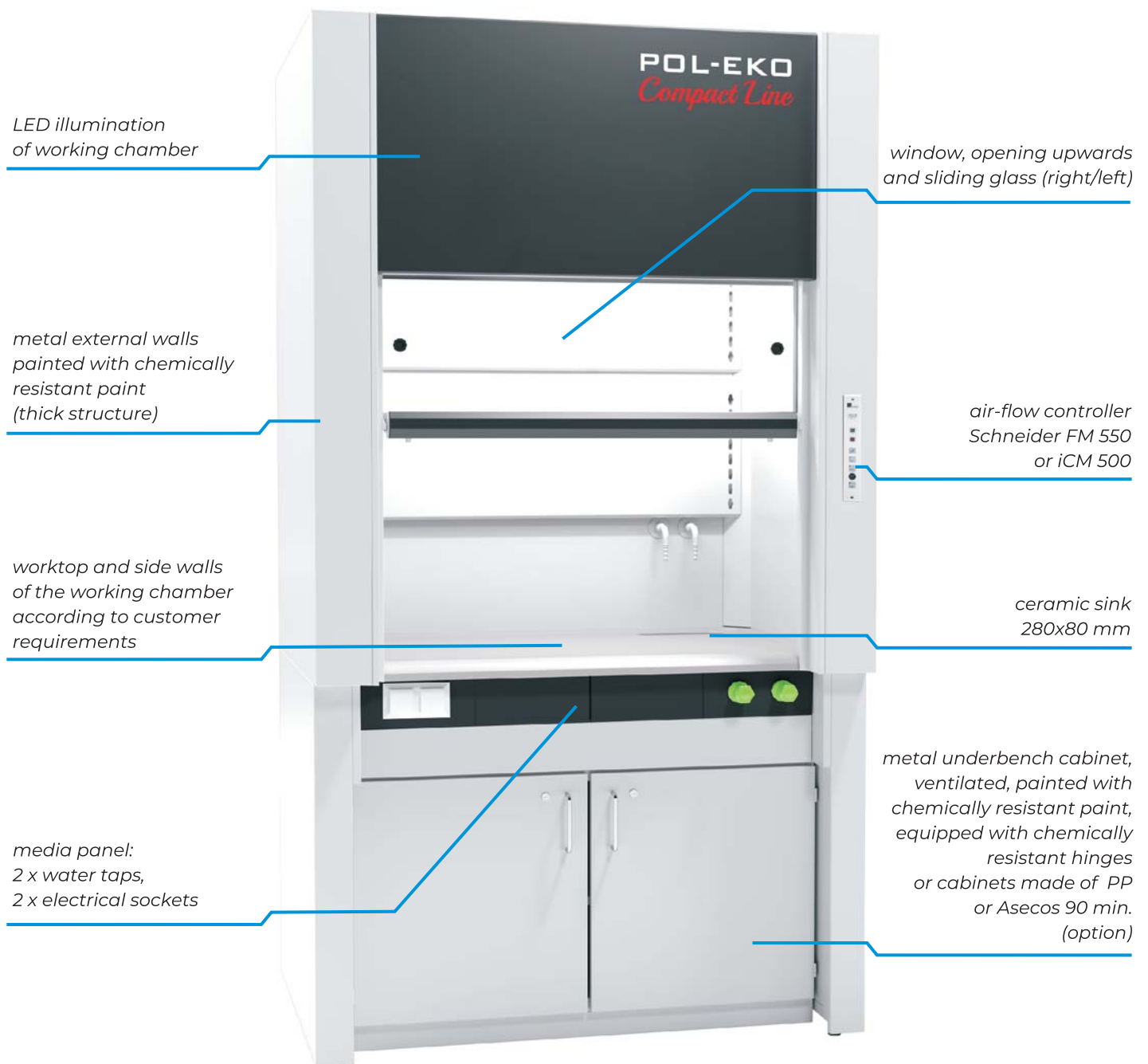

Compact Line DCL-12.00 fume hood

Common digitalisation, the Internet and unlimited access to information make us ensure that our offer is always up to date, complete, attractive and easily available to our customers. In our social media we present the everyday life in our company, as well as our CSR activities and many other social, educational and ecological actions that we organize or support. We also share information on achievements and our success story.



STANDARD EQUIPMENT

- monolithic ceramic worktop with marine edge
- 2 x 230V 50-60Hz electrical sockets
- 2 x water taps with valves in the front panel
- ceramic sink 280x80mm
- LED illumination of the working chamber
- air-flow sensor (Schneider FM 550-A-0-E)
- window, opening upwards at 500 mm height (max 810 mm / 1850 mm for Walk-in), sliding glass (right/left), system preventing uncontrolled window falling

AVAILABLE VERSIONS

- Compact Line DCL 1200 / 1500 / 1800
- Tabletop DCL 800 / 1200 / 1500
- Walk-in DCL 1200 / 1500 / 1800



OPTIONAL EQUIPMENT

- ventilated under bench cabinet made of steel covered with chemically resistant epoxy paint, chemically resistant hinges, connected to the ventilation system of fume hood, designed for short-term storage of reagents
- under bench cabinet for acids and alkalis made of polypropylene, for long-term storage
- fire resistant underbench cabinet ASECOS 90min, for flammable and hazardous substances storage (according to EN 14470-1)
- polypropylene trays
- 230V or 400V sockets
- fittings for distilled water, LPG and special gases (coloured according to EN 13782)
- automatic window
- main switch with safety button
- explosion-proof equipment (illumination, electric sockets with plug adapters)
- glazed side walls 700x500 mm, made of tempered safety glass 4 mm
- grate on the back wall made of stainless steel
- elements of the fume hood made of stainless steel according to DIN 1.4404 (construction, internal chamber, worktop, housing)
- air flow controller iCM 550 F or iCM 550 FP (see page 105)

Parameter		Compact Line DCL 12.00	Compact Line DCL 15.00	Compact Line DCL 18.00
overall dims [mm]	A width	1280	1580	1880
	B height	2325...2600	2325...2600	2325...2600
	C depth	960	960	960
working space dims [mm]	D width	1150	1450	1750
	D' width	965	1265	1565
	E height	1220	1220	1220
	F depth	635	635	635
recommended airflow [m³/h]	600...950	750...1200	900...1500	
required air-flow speed m/s	0,3...0,5	0,3...0,5	0,3...0,5	
nominal power [W]	46	82	82	
power supply	230V 50-60Hz			
electrical insulation class	class 1			
working chamber lighting/control	LED, class A++, through insulating window/control panel			
controller	Schneider FM 550-A-0-E with speed sensor, in AFS 100 window and FA-0025-3 control panel / iCM 500 (option)			
sash window opening	manual with counterweight			
sash window blockade at working level [mm]	500			
exit air sub pipe diameter [mm]	200	200	250	
ventilation/control system	double rear wall / control panel			
air-flow sensor	PN-EN 14175-2 compliant			
water connection	G 1/2" external thread			
sewage connection diameter [mm]	50			
frame and housing	galvanized sheet frame, epoxy coated galvanized steel housing			
working chamber	SS – epoxy coated galvanized steel LM – phenolic resin (option) PP – polypropylene (option) CR –large-size Buchtal ceramics (option)			
worktop	monolithic ceramics with marine edge/phenolic resin, epoxy, stainless steel to DIN 1.4301 or 1.4404 (option)			
warranty	24 months			
manufacturer	POL-EKO			

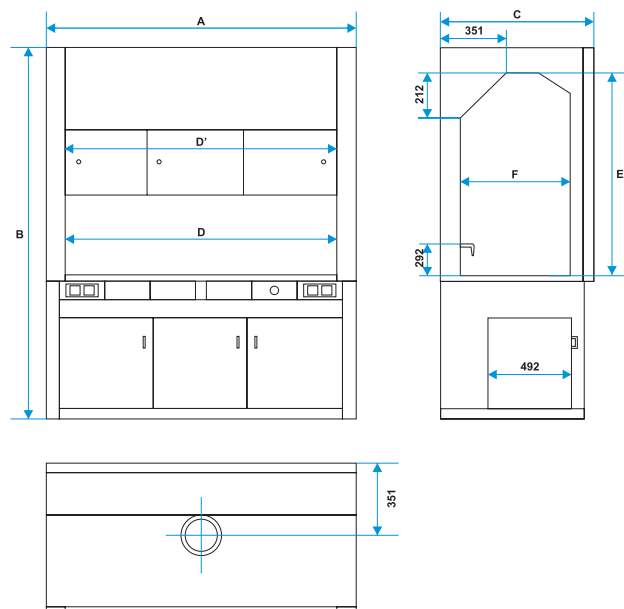

all the above technical data refer to standard units (without optional accessories)

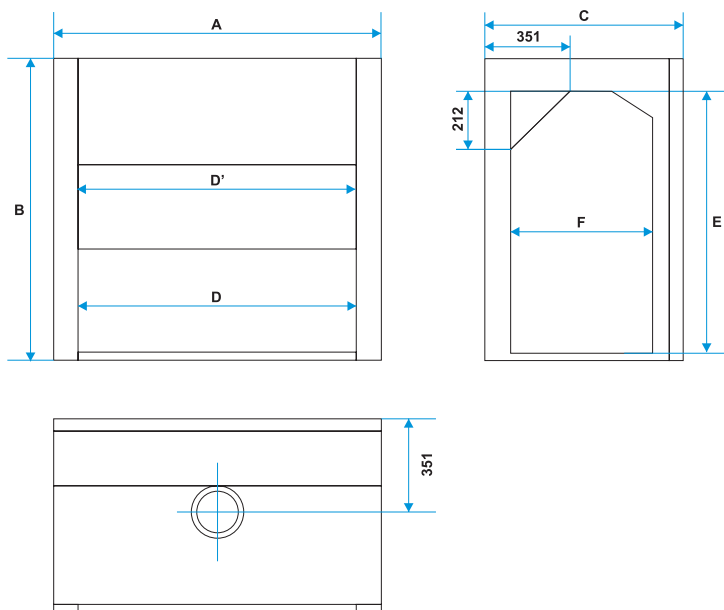

		Tabletop DCL 8.00	Tabletop DCL 12.00	Tabletop DCL 15.00
Parameter				
overall dims [mm]	A width	800	1200	1500
	B height	1235...1320	1235...1320	1235...1320
	C depth	700	700	700
working space dims [mm]	D width	734	1134	1434
	D' width	654	1054	1354
	E height	1000	1000	1000
	F depth	430	430	430
recommended airflow [m³/h]		400...650	600...950	750...1200
required air-flow speed m/s		0,3...0,5	0,3...0,5	0,3...0,5
nominal power [W]		46	46	46
power supply		230V 50-60Hz		
electrical insulation class		class 1		
working chamber lighting/control		LED, class A++, through insulating window/control panel		
controller		Schneider FM 550-A-0-E with speed sensor, in AFS 100 window and FA-0025-3 control panel / iCM 500 (option)		
sash window opening		manual with counterweight		
sash window blockade at working level [mm]		500		
exit air sub pipe diameter [mm]		160	200	200
ventilation/control system		double rear wall / control panel		
air-flow sensor		PN-EN 14175-2 compliant		
frame and housing		galvanized sheet frame, epoxy coated galvanized steel housing		
working chamber		SS – epoxy coated galvanized steel LM – phenolic resin (option) PP – polypropylene (option) CR –large-size Buchtal ceramics (option)		
worktop (option)		monolithic ceramics with marine edge, phenolic resin, epoxy, stainless steel to DIN 1.4301 or 1.4404 (option)		
warranty		24 months		
manufacturer		POL-EKO		

all the above technical data refer to standard units (without optional accessories)



		Walk-in DCL 12.00	Walk-in DCL 15.00	Walk-in DCL 18.00
Parameter				
overall dims [mm]	A width	1200	1500	1800
	B height	2385...2850	2385...2850	2385...2850
	C depth	1200	1200	1200
working space dims [mm]	D width	870	1170	1470
	D' width	810	1110	1410
	E height	2145	2145	2145
	F depth	845	845	845
recommended airflow [m³/h]		600...950	750...1200	900...1500
required air-flow speed m/s		0,3...0,5	0,3...0,5	0,3...0,5
nominal power [W]		46	82	82
power supply		230V 50-60Hz		
electrical insulation class		class 1		
working chamber lighting/control		LED, class A++, through insulating window/control panel		
controller		Schneider FM 550-A-0-E with speed sensor, in AFS 100 window and FA-0025-3 control panel / iCM 500 (option)		
sash window opening		manual with counterweight		
sash window blockade at working level [mm]		no window blockade		
exit air sub pipe diameter [mm]		250	250	250
ventilation/control system		double rear wall / control panel		
air-flow sensor		PN-EN 14175-2 compliant		
frame and housing		galvanized sheet frame, epoxy coated galvanized steel housing		
working chamber		SS - epoxy coated galvanized steel LM - phenolic resin (option) PP - polypropylene (option) CR -large-size Buchtal ceramics (option)		
warranty		24 months		
manufacturer		POL-EKO		

all the above technical data refer to standard units (without optional accessories)

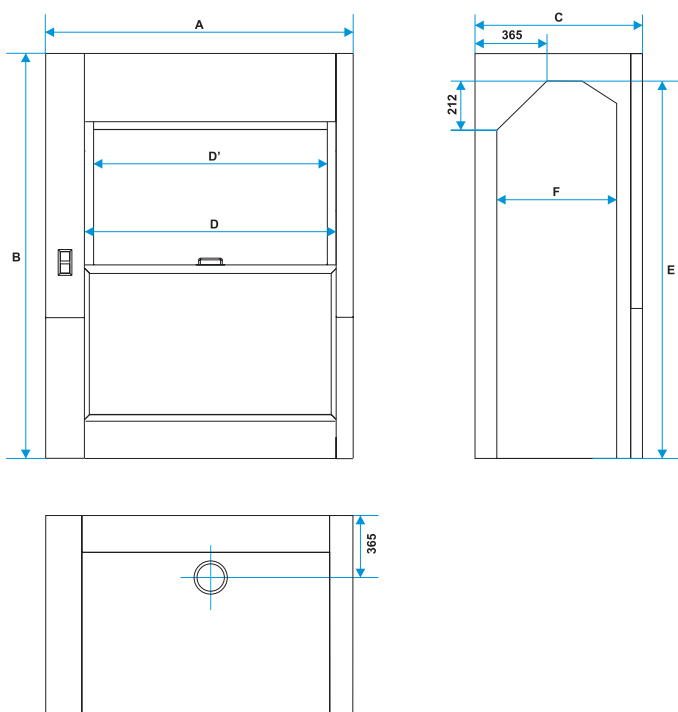

CONTROLLERS

FM 550

- control functions with visual and sound alarms in case of low air flow (in accordance with PN-EN 14175)
- sash window height alarm
- airflow measurement [m^3/h]
- fume hood illumination control



iCM 500 F

- microprocessor controller for regulation and monitoring of fume hood face velocity [m/s]
- visual and sound alarm in case of emergency
- control panel with fully graphic and numerical LC-display
- throttle with high-speed actuator



iCM 500 FP

- microprocessor controller for regulation and monitoring of face volumetric air flow rate [m^3/h]
- visual and sound alarm in case of emergency
- control panel with fully graphic and numerical LC-display
- works with Building Management System (BMS)

Automatic Sash Controller SC 500

Infrared light barrier transmitter/receiver for registering objects during the closing proces.
Foot switch for opening the sash (option).

WORKING CHAMBER FINISHING

SS variant

worktop – solid ceramics th. 27 - 33 mm,
with marine edge, ceramic sink (dims 280 x 80 mm)
is mounted under the worktop, internal chamber side walls
made of steel, covered with chemically resistant epoxy paint.



CR variant

worktop – solid ceramics th. 27 - 33 mm,
with marine edge, ceramic sink (dims 280 x 80 mm)
is mounted under the worktop, internal chamber side walls
made of 8 mm Buchtal ceramic.



PP variant

worktop – solid ceramics th. 27 - 33 mm,
with marine edge, ceramic sink (dims 280 x 80 mm)
is mounted under the worktop, internal chamber side walls
made of polypropylene.



LM variant

worktop – solid ceramics th. 27 - 33 mm,
with marine edge, iceramic sink (dims 280 x 80 mm)
is mounted under the worktop, internal chamber side walls
made of Max Resistance phenolic resin composite.



■ Exemplary Compact Line fume hood with additional equipment

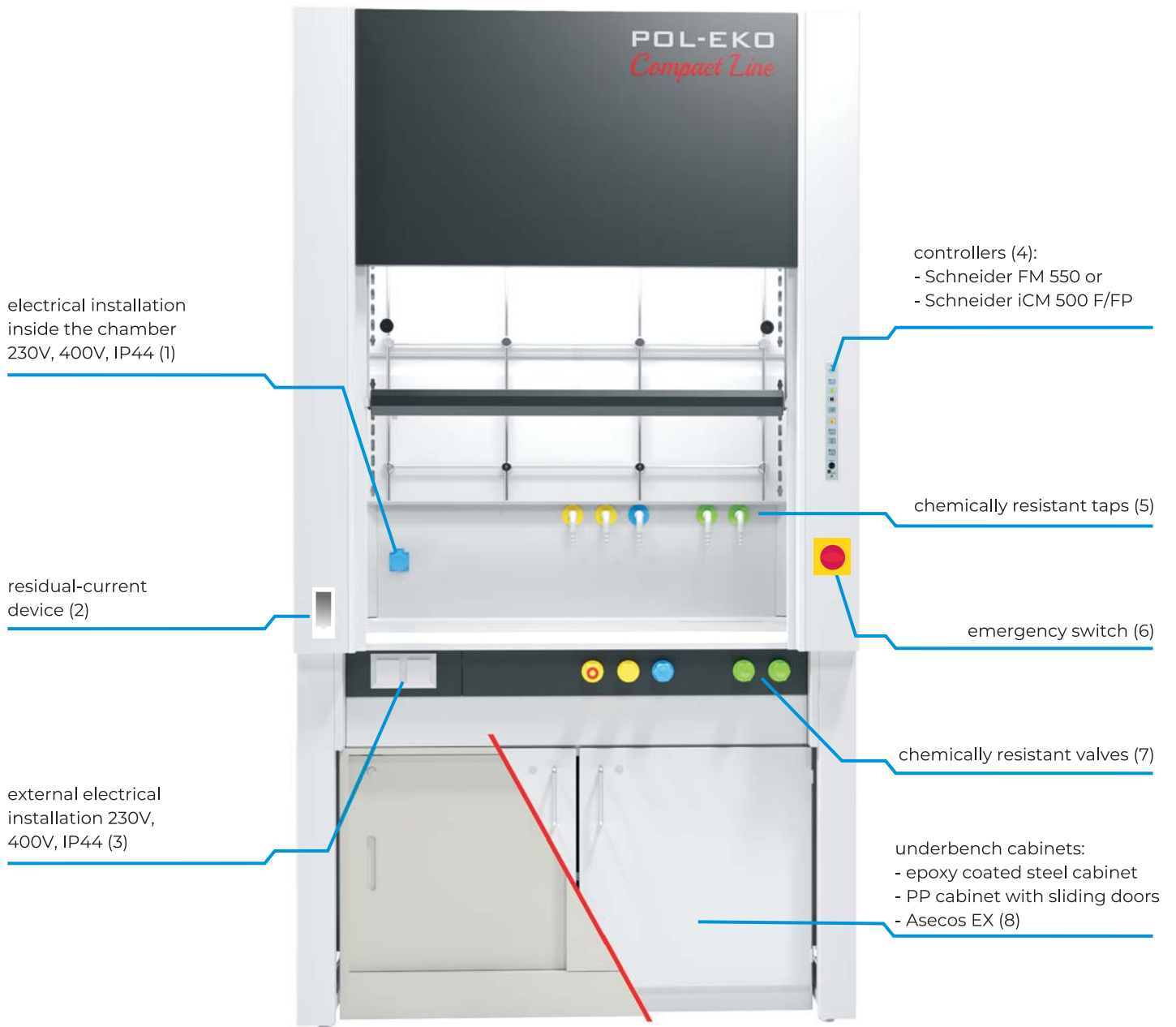



ADDITIONAL EQUIPMENT

■ Non-standard equipment

We have our own engineering and technical facilities thanks to which we are able to design and manufacture non-standard equipment which will meet the requirements of the most unusual applications.

Depending on the individual requirements of customers, the units may have non-standard dimensions and equipment, various temperature ranges as well as an unusual color or type of coating.

Together with our customers, we have already completed many very interesting projects. Some of them are presented below.

■ Equipment with non-standard dimensions

- drying oven 2500l
- two-chamber drying oven SLW 500/SLW 500 with the door with viewing window
- pass-through sterilizer 3100l with trolleys
- drying oven 5000l with the possibility of access by a pallet truck
- dry-aging chambers for meat equipped with reinforced shelves and hooks



■ Equipment with rotating mechanisms

- laboratory incubator with a built-in slow-rotating grate that allows to mix the content of the bottles
- drying oven with tilting shelf - shelf connected with a lever placed outside, allows you to change the angle of its inclination - a mechanism used to test the flow path of e.g. resins

■ Equipment with non-standard illumination

- ST and ILW cooled incubators and incubators with UV-C light
- ST 1-6 cooled incubators with FIT option in side walls
- climatic chambers with phytotron with additional UV light
- ST cooled incubators with illumination in the form of LED strips



ZA Emergency power supply



The emergency power supply system (ZA) ensures that refrigerators and freezers maintain operating in the event of power outage. It also protects from power supply interferences. The system enables safe operation of your equipment until a stable power supply has been restored or the battery is completely discharged.

In case of storing drugs and vaccines, the battery-powered operation of pharmaceutical refrigerators maintains the "cold chain", even in the event of a power outage of 4 to 30 hours.

Standard features

- converter with battery charging function
- battery (ies)
- castors
- visual and sound alarm on the operating status
- electric socket type E (230V)
- English instruction manual



ZA emergency power supply can work with all models of CHL laboratory refrigerators, ST cooled incubators, ZL freezers and ILW cooled incubators (ILW 240, 400, 750 models). Battery operation time depends on the size of the unit and selected model.

Why not the classic "UPS"?

A dedicated battery backup system is necessary for emergency power supply for units equipped with a compressor-based cooling system. At the start of the compressor, the electric current consumption is several times higher than the rated current, which in classic "UPS" used for emergency backup of, for example, computers, triggers safety and automatic shutdown. The emergency power supply produced by POL-EKO can be overloaded by up to 300% for 20 seconds, which allows the compressor to start easily. Additionally, the compressor requires a "clean" sign wave on the power supply. UPSes typically provide voltage with a rectangular or approximate characteristics that can damage the compressor winding.

Parameter	ZA I 6H	ZA I 12 H		ZA I 30H	ZA II 4H	ZA II 8H		ZA II 12H
backup time* [h]	6	12	10	30	4	8	4	12
external dimensions [mm]	A width	660	660	675	660	675		675
	B height	670	670	670	670	670		670
	C depth	375	375	665	375	665		665
weight [kg]	74	105		168	110	173		235
number of batteries [pcs.]	1	1		2	1	2		3
works with the model	CHL/ST 1-6, ZLN85	CHL/ST 1-6	ZLN 85	CHL/ST 1-6	CHL/ST 500-1450 ILW 240-750	CHL/ST 500-1450 ILW 240-750	ZL-T	CHL/ST 500-1450 ILW 240-750
housing material	powder coated sheet							
power / voltage	230V 50-60Hz							
warranty	12 months							
manufacturer	POL-EKO							

* approximate time of maintaining the operation of the unit with ZA option, depends on the environmental parameters, the chamber load, etc.

■ FEKO+ waste water receipt station

FEKO+ is a waste water receipt station intended to work at waste water treatment plants and sewage pumping stations. It can identify the origin of the sewage, as well as each carrier. Moreover, it is able to measure the volume and various parameters of the disposed sewage, such as pH, temperature and conductivity to ensure full monitoring of the waste water.

External control and identification cabinet, made of stainless steel DIN 1.4301, features:

- 7" or 10" colour LCD touch screen
- control system with data archiving
- Windows Embedded based software
- internal memory (city, property address)
- Ethernet communication module (Feko+ Client program) or Wi-Fi (option)
- USB port for data transfer and manual station programming
- MODBUS RTU / TCP or Profibus communication protocol (option)
- RFID key rings 20 pcs.
- carriers identification module
- waste water type identification module
- modular printer with paper cutter
- stainless steel industrial keyboard



■ EuroDrop station

The Eurodrop is a waste water receipt station intended for coaches and motorhomes. Standard models are equipped with a flushing function which allows to empty the chemical WC tank, as well as the "grey water" tank. In addition, the Eurodrop stations provide access to drinking water which can be taken to the tank in a coach or camper. What's more, the station has two models of electrical outlets which fit most camper vans.

Standard equipment:

- outdoor LED lighting controlled by astronomical clock
- chemical WC emptying point
- "grey water" emptying point (optional)
- 2 power outlets 1000W and 2000W (optional up to 3680W)
- 2 drinking water nozzles
- 1 non-drinking water nozzle (for flushing chemical WC tank)
- 2 flushing nozzles (for flushing both chemical WC and "grey water" emptying points)

■ HYDROMAT water dispenser

HYDROMAT is a station for the automatic dispensing of water, recommended for municipalities with water shortage and lack of water supply system. Water can be taken from a large distributor using the DN80 fire-fighting connector (for large tanks, barrels) or from a small distributor (tap).

Standard equipment:

- backlit and clear LCD display
- control buttons
- RFID proximity card reader
- water meters
- photovoltaic panels (optional)
- coin acceptor (optional)



POL-EKO LAB is accredited by the Polish Centre for Accreditation (a member of ILAC) and provides accredited services



■ We provide accredited calibration services of:

- thermostatic and climatic chambers, method temperature range: -80...+200°C
- climatic chambers in the range of relative humidity, method temperature range: +10...+60°C for humidity 20... 98%
- water baths and thermoreactors, method temperature range: -25...+200°C
- lab furnaces, method temperature range: +100...+1100°C
- chambers for steam sterilization (autoclaves), method temperature range: +60...+140°C

After the service has been performed, the client receives a Calibration Certificate, in which the following information is presented: average temperature / humidity at each point, optional effect of the load, measurement uncertainty, temperature / humidity stability.

■ We also provide accredited calibration services for:

- electric and electronic thermometers and data loggers with an external sensor, method temperature range: -80...+1100°C
- electric and electronic thermometers and data loggers with an internal sensor, method temperature range: 0...+140°C
- thermohygrometer, method temperature range: +10...+60°C, method relative humidity range: 20...98%

After the service has been performed, the client receives a calibration certificate, in which the following information is presented: average value of temperature / humidity, correction of temperature / humidity value, measurement uncertainty.

■ Calibration of laboratory sieves

- laboratory sieves, method measuring range: 0,02... 125 mm



AP 115

Detailed information about our services is available on the website of the Polish Centre for Accreditation under the accreditation number AP 115 www.pca.gov.pl and on our website www.polekolab.pl.

■ Non-accredited services:

- qualification procedures IQ, OQ, PQ
- thermostatic and climatic chambers
- autoclaves
- high temperature furnaces

temperature and humidity mapping in rooms and cars

- temperature range: -30 ... +70°C
- relative humidity range: 10 ... 90%

Comprehensive services for the supervision of measuring equipment

POL-EKO Laboratorium Pomiarowe sp. z o.o.
ul. Kokoszycka 172C | 44-300 Wodzisław Śląski
tel. 32 453 91 97 | e-mail: lab@pol-eko.com.pl
www.polekolab.pl

2023

POL-EKO

Manufacturer of laboratory equipment,
fume hoods and on-line instruments.

POL-EKO sp. k.
ul. Kokoszycka 172C
44 - 300 Wodzisław Śląski
POLAND
Tel: +48 32 453 91 70

E-mail: export@pol-eko.com.pl
www.pol-eko.com.pl



like us on
facebook

facebook.com/polekoofficial

Catalogue "Products of POL-EKO" version 15/2023.

While we make every effort to provide accurate technical data, inconsistencies may occur.
We reserve the right to change technical specifications without notice.

All dimensions are given exact to ± 5 %.