



-20°C Laboratory and Enzyme Freezers

TSX Series

Installation and Operation

327931H01 Rev. A August 2016

Visit us online to register your warranty
www.thermofisher.com/labwarranty

thermoscientific

IMPORTANT Read this instruction manual. Failure to follow the instructions in this manual can result in damage to the unit, injury to operating personnel, and poor equipment performance.

CAUTION All internal adjustments and maintenance must be performed by qualified service personnel.

Material in this manual is for informational purposes only. The contents and the product it describes are subject to change without notice. Thermo Fisher Scientific makes no representations or warranties with respect to this manual. In no event shall Thermo be held liable for any damages, direct or incidental, arising from or related to the use of this manual.

© 2016 Thermo Fisher Scientific Inc. All rights reserved.

For your future reference and when contacting the factory, please have the following information readily available. It can be found on the dataplate attached to your unit.

Model Number: _____

Serial Number: _____

The following information, if available, is helpful for contacting the factory.

Date Purchased: _____

Purchase order number: _____

Source of Purchase: _____

(manufacturer or specific agent/rep organization)

Table of Contents

Models	1
Safety Precautions	2
Unpacking	4
Packing List	5
General Recommendations	6
Temperature Monitoring	6
Intended Use	6
Operating Standards	7
Unit Specifications	7
Installation	8
Location	8
Leveling	8
Wiring	8
Shelves	9
Drawers	9
Baskets	13
Anti-Tip Brackets	13
Door Operation	15
Remote Alarm (Optional)	16
Final Checks	17
Startup	18
Initial Startup	18
Product Loading and Unloading Guidelines	18
Operation	19
Control Panel	19
Display Functions	21
Programming Functions	22
Service Parameters	22
Temperature Settings	24
Alarms	24
Chart Recorder (Optional)	26
Set Up and Operation	26
Changing Chart Paper	27
Power Supply	27
Calibration and Adjustments	28
Temperature Transmitter	29
Maintenance	30
Cleaning the Cabinet Interior	30
Cleaning the Condenser Filter	30

Table of Contents

Cleaning the Condenser	30
Defrost	31
Gasket Maintenance	31
Alarm Battery Maintenance	31
Troubleshooting	32
End of Life Care.....	34
Warranty	35

1 Models

The table below shows the units covered in this operation and installation manual by model number. Refer to *Section 6.1* for details on the voltage specifications for the various models.

Table 1. Applicable Models

Unit	Model (*)
Thermo Scientific - TSX2320F*	A/D/V
Thermo Scientific - TSX2320E*	A/D/V

2 Safety Precautions

In this manual, the following symbols and conventions are used:



This symbol when used alone indicates important operating instructions which reduce the risk of injury or poor performance of the unit.



WARNING: This symbol indicates potentially hazardous situations which, if not avoided, could result in serious injury or death.



WARNING: This symbol indicates situations where dangerous voltages exist and potential for electrical shock is present.



WARNING: This symbol indicates potentially hazardous situations, which if not avoided could result in fire.



CAUTION: This symbol, in the context of a CAUTION, indicates a potentially hazardous situation which if not avoided could result in minor to moderate injury or damage to the equipment.

CAUTION: This indicates a situation which may result in property damage.



This symbol indicates surfaces which may become hot during use and may cause a burn if touched with unprotected body parts.



Before installing, using or maintaining this product, please be sure to read the manual and product warning labels carefully. Failure to follow these instructions may cause the product to malfunction, which could result in injury or damage.



This symbol indicates possible pinch points which may cause personal injury.



The snowflake symbol indicates low temperatures and risk of frost bite. Do not touch bare metal or samples with unprotected body parts.



This symbol indicates a need to use gloves during indicated procedures. If performing decontamination procedures, use chemically resistant gloves. Use insulated gloves for handling samples.

Below are important safety precautions that apply to this product:



Use this product only in the way described in the product literature and in this manual. Before using it, verify that this product is suitable for its intended use. If the equipment is used in a manner not specified by the manufacturer, the protection provided by the equipment may be impaired.



Do not modify system components, especially the controller. Use OEM exact replacement equipment or parts. Before use, confirm that the product has not been altered in any way.



WARNING: Your unit must be properly grounded in conformity with national and local electrical codes. Do not connect the unit to overloaded power sources.



WARNING: Disconnect the unit from all power sources before cleaning, troubleshooting, or performing other maintenance on the product or its controls.



WARNING: This unit is not for storage of flammable materials.



WARNING: This unit is charged with hydrocarbon refrigerants. Only qualified service personnel should service this unit.



WARNING: Unauthorized repair of your freezer will invalidate your warranty. Contact Technical Service at 1-800-438-4851 for additional information.

3 Unpacking

At the time of delivery, be sure to inspect the unit packaging for damage before signing for the shipment. If packaging damage is present, request immediate product inspection and file a claim with the carrier.

Note Packaging damage does not denote that unit damage exists.

If concealed damage is found (damage that is not apparent until the item has been unpacked), stop further unpacking and save all packing for carrier's inspection. Make a written request for inspection to delivering carrier. This must be done within 15 days after delivery. Then file a claim with the carrier.

Do not return goods to the manufacturer without written authorization.

4 Packing List

Inside the freezer cabinet is a bag containing:

- USB Drive with this and other user manuals, including translated versions
- Certificate of Conformance
- Warranty Card
- Quick start guide
- Two control panel keys (silver)
- Two cabinet door keys (gold)
- Enzyme bins (Enzyme Freezer Only)

If the unit was ordered with shelves, the bag will also include:

- Small bag with shelving clips

If the unit was ordered with a chart recorder, the bag will also contain:

- Chart recorder pamphlet
- Extra chart recorder paper

If specified on the order, the bag may also include:

- QC temperature graph and test log
- Calibration information

Other items with your unit include:

- Power Cord
- Anti-Tip Bracket Kit
- Baskets, Shelves or Drawers

5 General Recommendations

This section includes some general recommendations for your unit.

5.1 Temperature Monitoring



IMPORTANT NOTE We recommend the use of a redundant and independent temperature monitoring system so that the freezer can be monitored continuously for performance commensurate with the value of product stored.

5.2 Intended Use

The -20°C Laboratory and Enzyme Freezers described in this manual are high performance units for professional use. These products are intended for use as cold storage in research use and as a general purpose laboratory freezer, storing samples or inventory at operating temperatures between -30°C and -15°C.

It is not considered a medical device and has therefore not been registered with a medical device regulatory body (e.g. FDA): that is, it has not been evaluated for the storage of samples for diagnostic use or for samples to be re-introduced to the body.

This unit is not intended for use in classified hazardous locations, nor to be used for the storage of flammable or corrosive inventory.



CAUTION: Storage of unsealed corrosive substances may cause the interior of the unit to corrode.

6 Operating Standards

The freezers described in this manual are classified for use as stationary equipment in a Pollution Degree 2 and Overvoltage Category II environment.

These units are designed to operate under the following environmental conditions:

- Indoor use
- Altitude up to 2000 m (6512 feet)
- Maximum relative humidity 60% for temperatures from 15 to 32°C (59 to 90°F).
- Main supply voltage fluctuations not to exceed 10% of the nominal voltage.
- The freezer must not be connected to a GFCI (Ground Fault Circuit Interrupter) protected outlet as it may be subject to nuisance tripping.

6.1 Unit Specifications

The last character in the model number listed on the freezer identifies the electrical specifications for your unit.

The dataplate is located on the upper left side of the unit.

Table 2. Unit Specifications

Model	Rated Voltage	Rated Current	Frequency / Phase	Power Module Plug	Weight Kg (lbs) [†]	Exterior Dimensions (H x D x W)
A	115V	4.3 A	60Hz/1	IEC C19	176 (388)	199.7 x 93.8 x 71.1 cm (78.6 x 36.9 x 28.0 in)
D	208-230V	2.5 A	50/60Hz/1		166 (367)	
V	208-230V	2.5 A	50/60Hz/1		166 (367)	

[†]Weight provided is for Laboratory Freezer (TSX2320F*). For an Enzyme Freezer (TSX2320E*), add 25 Kg (55 lbs).

7 Installation



WARNING: Do not exceed the electrical rating printed on the dataplate located on the upper left side of the unit.

7.1 Location

Install the unit on a level area free from vibration with a minimum of 6 inches of space on the sides and rear and 12 inches at the top. Do not position the equipment in direct sunlight or near heating diffusers, radiators, or other sources of heat.

7.2 Leveling

Make sure that the floor is level. The unit must be level both front to back and side to side. If the unit is out of level, you may need to shim the corners or casters with thin sheets of metal. Be sure to set the brakes for units equipped with casters.

7.3 Wiring

The wiring diagrams are attached on the back of the cabinet.



CAUTION: Connect the equipment to the correct power source. Incorrect voltage can result in severe damage to the equipment.



CAUTION: For personal safety and trouble-free operation, this unit must be properly grounded while in use. Failure to ground the equipment may cause personal injury or damage to the equipment. Always conform to the National Electrical Code and local codes. Do not connect the unit to overloaded power lines.



CAUTION: Do not position the unit in a way that impedes access to the disconnecting device or circuit breaker in the back of the unit.



CAUTION: Always connect the unit to a dedicated (separate) circuit. Each unit is equipped with a service cord and plug designed to connect it to a power outlet which delivers the correct voltage. Supply voltage must be within $\pm 10\%$ of the unit rated voltage. If cord becomes damaged, replace with a properly rated power supply cord.

Table 3. Power Cord Specifications

Model	Power Cord Specifications
A	3-G 12 AWG, NEMA 5-15P, 15A/125V
D	3-G 14 AWG, NEMA 6-15P, 15A/250V
V	3-G 1.5 mm ² , CEE 7/7, 16A/250V



CAUTION: Never cut the grounding prong from the service cord plug. If the prong is removed, the warranty is invalidated.



CAUTION: In an emergency, the power cord is a disconnect device.

7.4 Shelves

All the freezers come standard with wire shelves. Laboratory freezers come standard with 4 shelves. Enzyme freezers come standard with 45 enzyme bins and 9 wire shelves which have a rail at the front. Additional shelves are offered as available options.

Maximum shelf capacity is 45 kg (100 lbs). Enzyme unit total shelf capacity is 340 kg (750lbs). With even weight distribution, each shelf would hold 37.8 kg (83 lbs).

For safety in shipping, the shelves are packaged and secured inside the cabinet. Insert the shelf support hangers (included with the manual inside the unit) into the built-in shelf supports (located on the inside walls of the cabinet interior) at the desired locations. Position the shelves on the flat supports (refer to *Figure 1*).

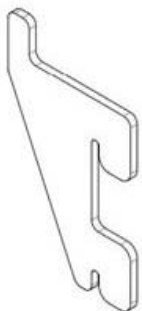

Figure 1. Shelf Support Hanger

7.5 Drawers

Laboratory freezers have the option to be ordered with 7 drawers.

Drawers are shipped in a factory installed position that promotes uniform spacing between the drawers. The drawer slides are adjustable to higher and lower positions in the cabinet. You can position these slides in the vertical slots which are spaced at one-inch intervals. The drawers must be removed in order to adjust the position of the drawer slides.

The maximum drawer capacity is 27 kg (60 lbs).

7.5.1 Removing the Drawers

To remove the drawers, complete the following steps (refer to *Figure 2*):

1. Pull the drawer towards you until the slides are fully extended.
2. Lift the back of the drawer to disengage the mounting tabs from the slots on the slides.



Note The drawers fit snugly between the slides. Push the back to the drawer from underneath to remove the drawer.

3. Raise the back of the drawer almost to a vertical position and disengage the front mounting clips from the sides.

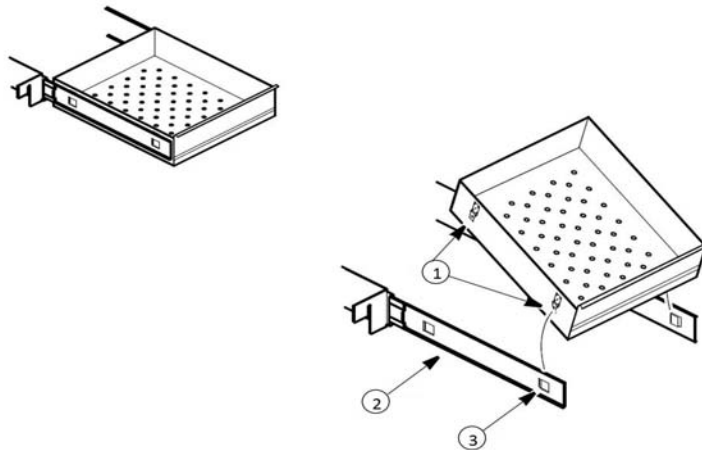

Figure 2. Drawer Removal

Label	Description
1	Tabs
2	Drawer slide
3	Slot

7.5.2 Reinstalling the Drawers

To reinstall the drawers, complete the following steps (refer to *Figure 2*):

1. Pull both the slides of the drawer towards you until the slides are fully extended.
2. Position the drawer between the slides and with the back facing end raised at 45 degree angle, insert the mounting clips at the front into the slots on front of the slides.
3. Push the back of the drawer down between the slides and insert the basket tabs into the slots at the back.



Note The drawers fit snugly between the slides. Push on the back of the drawer from the inside to insert the drawer tabs completely into the slots. Make sure both the drawer tabs are aligned with the slots on the slides before pushing the drawer down between the slides.



CAUTION: Be careful when reinstalling the drawers to avoid possible pinching.

7.5.3 Changing Drawer Position

Drawer slides have a small wire safety clip at the front pilaster which prevent the slides from falling when the drawer is removed. To change the position of the drawer slides, complete the following steps:

1. Locate the safety clip.
2. Slip a small screwdriver under the bottom of the wire clip and pry the clip towards the inside of the freezer.

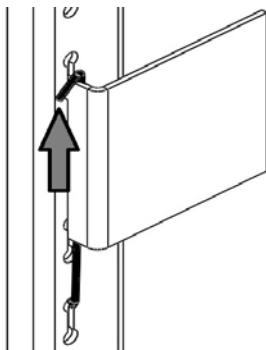

Figure 3. Clip Removal

3. Lift up the slide at the front. The slide is free to move from the front pilaster.

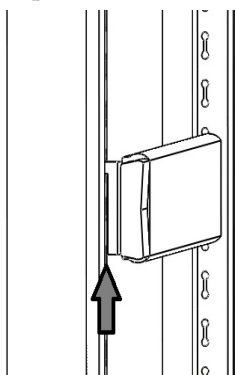

Figure 4. Front of slide Removal

4. The drawer slide must be removed from the rear pilaster at approximately a 45 degree angle towards the center of the cabinet.

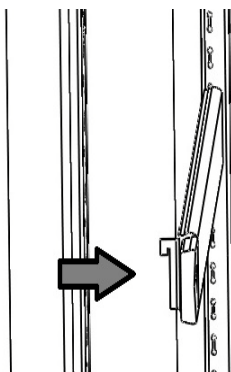

Figure 5. Slide Rotation

5. Pull the slide towards the front of the cabinet.
6. Determine desired location for the slide and insert the slide into the rear pilaster at a 45 degree angle towards the center of the cabinet.
7. Once the slide is seated in the rear pilaster, rotate the slide until it is parallel with the unit wall and insert slide into front pilaster.

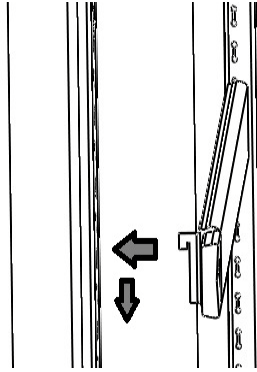

Figure 6. Slide Installation



CAUTION: Ensure the slide is level. If the slide is not seated in a level orientation, the drawers/baskets will not function as intended. This could cause injury or product damage.

8. Replace the safety clip by hooking the clip under the front pilaster slide bracket. Then rotate the wire safety clip to position the other bend of the clip over the top of the same bracket.

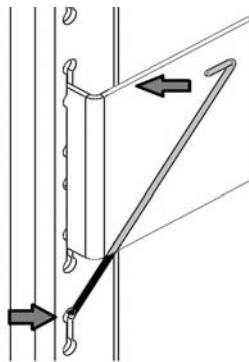

Figure 7. Clip Replacement



CAUTION: Drawer slides do *not* require lubrication. Additional lubricant could impede movement of the drawers when lubricant is cold.

7.6 Baskets

Laboratory freezers have the option to be ordered with 6 wire baskets.

Baskets are shipped in a factory installed position that promotes uniform spacing between the baskets. The basket slides are adjustable to higher and lower positions in the cabinet. You can position these slides in the vertical slots which are spaced at one-inch intervals. The baskets must be removed in order to adjust the position of the slides. The procedure for removing, reinstalling, and changing position of the baskets can be found in *Section 7.5.1*, *Section 7.5.2*, and *Section 7.5.3*.

The maximum basket capacity is 27 kg (60 lbs).

7.7 Anti-Tip Brackets



WARNING: The freezer must be secured by the anti-tip bracket supplied. Unless properly installed, the freezer could tip when shelves/drawers/baskets are loaded. Injury and damage to the equipment and contents may result from the freezer tipping.

This freezer has been designed to meet all recognized industry tip standards for all normal conditions when anti-tip bracket is installed and properly engaged.

7.7.1 Installation Instructions

Installation instructions are provided for wood and concrete floors. Any other type of construction may require special installation techniques as deemed necessary to provide adequate fastening of the anti-tip bracket to the floor. For installation on floors other than wood and concrete, please contact technical support.

The use of this bracket does not prevent the tipping of the freezer when not properly installed.

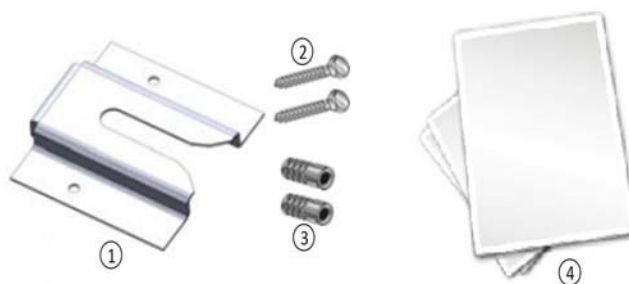

Figure 8. Materials Supplied

Label	Description
1	Bracket
2	Bolts
3	Anchors
4	Instructions and Installation Template

Table 4. Tools required

Wood Floor	Concrete Floor
Flashlight	
Tape Measure	
1/2" (13 mm) Wrench	
3/4" (19 mm) Wrench	
Drill	Hammer Drill
15/64" (6 mm) Drill Bit	1/2" (13 mm) Masonry Bit

1. Locating the Bracket

- a. Determine where you want the centerline of the freezer to be.
- b. Place the included template on the floor lined up with the centerline of the freezer and keep 6"-12" between the wall and the back of the unit.
- c. On the floor, mark the location of Hole #1 & Hole #2.

2. Anti-Tip Bracket InstallationWood Construction

- a. Drill 15/64" (6 mm) pilot holes in locations marked in step 1.
- b. Place bracket on floor aligned with holes.
- c. Use supplied lag bolts to attach bracket to floor.

Concrete Construction

- a. Drill 1/2" (13 mm) holes in locations marked in step 1 with masonry bit.
- b. Slide lag screw anchors into holes to be flush with floor surface.
- c. Place bracket on floor aligned with holes.
- d. Use supplied lag bolts to attach bracket to floor.

3. Adjusting Bolt in freezer

- a. Locate 1/2" bolt attached to bottom of cabinet.
- b. Unscrew 1/2" bolt until there is 1/2" clearance between floor and head of bolt as shown in *Figure 9* below.
- c. Tighten lock nut against bottom of unit.

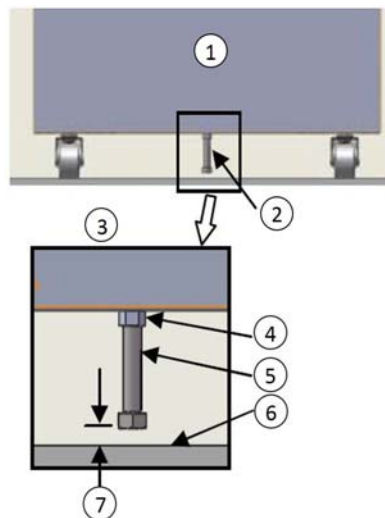

Figure 9. Bolt Location

Label	Description
1	Back of Unit
2	1/2" Bolt Location
3	Detailed View
4	Lock Nut
5	1/2" Bolt
6	Floor
7	1/2" Clearance

4. Freezer Positioning

- a. Line up 1/2" bolt installed in step 3 with anti-tip bracket.
- b. Roll or slide freezer into position until bolt stops against bracket.
- c. Lock the casters.

5. Checking the Installation

6. Check to see if the anti-tip bracket is installed properly by shining light under cabinet and confirming bolt in cabinet is secured by bracket on floor.

7.8 Door Operation

The doors on all units are designed to stay open if opened 90 degrees or more. The door spring tension cannot be adjusted.

If the self-closing door does not work properly, make sure the unit is level.

7.8.1 Door Seal



CAUTION: Door seal integrity is critical for freezer performance. A loose fitting gasket allows moist air to be drawn into the cabinet, resulting in quicker frost buildup on the cabinet walls, longer running time, poor temperature maintenance, and increased operation cost.

7.9 Remote Alarm (Optional)

All units have factory-installed local alarm contacts that can be used for remote alarm systems.

The maximum distance between a freezer and a remote alarm depends on the wire gauge used. Refer to *Table 5* below:

Table 5. Wire Gauges and Distance to Remote Alarm

Wire Gauge	Total Wire Length (feet)	Distance to Alarm 1/2 Wire Length (feet)
20	530	265
18	840	420
16	1330	665
14	2120	1060
12	3370	1685

Remote alarm terminals are located at the rear of the machine compartment. The three terminals are: COMMON, OPEN ON FAIL (Normally Closed), and CLOSE ON FAIL (Normally Open).

REMOTE ALARM CONNECTIONS
CONNEXIONS DE L'ALARME À DISTANCE

CONTACT RATING 1 AMP MAX
CLASS 2 CIRCUIT ONLY
VALEUR NOMINALE DE CONTACT DE 1 AMP MAX.
SUR UN CIRCUIT DE CLASSE 2 UNIQUEMENT



Figure 10. Remote Alarm Diagram

To install the remote alarm, make the following connections:

1. Connect the COMMON terminal on the cabinet switch to the COMMON wire on the alarm.
- 2a. To get an alarm when the switch contacts open, connect the OPEN ON FAIL terminal on the cabinet to the OPEN ON FAIL wire on the alarm.
- 2b. To get an alarm when the switch contacts close, connect the CLOSE ON FAIL terminal on the cabinet to the CLOSE ON FAIL wire on the alarm. The COMMON and CLOSE ON FAIL wires must be tied together in this application.
3. Plug the alarm system service cord into an electrical outlet.

The contacts will trip in the event of a power outage, high temperature alarm or low temperature alarm

7.10 Final Checks

Before start up, be sure to complete the following steps:

1. Make sure that the unit is free of all wood or cardboard shipping materials, both inside and outside.
2. Check the positions of the shelves, drawers or baskets. If you want to adjust the positions, see instructions in *Section 7.4*, *Section 7.5* and *Section 7.6*.
3. Verify that the unit is connected to a dedicated circuit.

8 Startup

8.1 Initial Startup

To start up the freezer, complete the following steps:

1. Ensure the double pole circuit breaker switch located next to the power inlet is in “ON” position (i.e. “I” position).
2. Insert the silver colored key in the switch and turn to the **Power On** position. The display will show the actual cabinet temperature and the compressor should start within 10 minutes.
3. Allow the unit to reach operating temperature before loading it with any product. To stabilize the temperature profile, a 24-hour waiting period is recommended.
4. If you desire to enable the alarms, turn the three position key switch one turn further clockwise to the **Alarm On** position. To avoid nuisance alarms, wait until the unit has pulled down to the desired operating temperature (-20°C default).
5. If you have a remote alarm, hook it up at this point (refer to *Section 7.9*).
6. If desired, lock the cabinet door using the gold colored key. Place duplicate key copies in a safe place.

All controls should now be fully operational, the alarm active (if enabled), and all visual indicators active.



CAUTION: Use gloves when handling samples to avoid potential frost bite.

8.2 Product Loading and Unloading Guidelines

When loading your freezer, take care to observe the following guidelines:

- Distribute the load as evenly as possible. Temperature uniformity depends on air circulation, which could be impeded if the internal storage components are overfilled, particularly at the top of the cabinet.
- For critical applications, be sure that the alarm systems are working and active before you load any product.
- Ensure clearance between the top of the cargo and the bottom of the internal storage components. Lack of clearance may affect unit performance or impede operation of the storage component.
- For initial product loading and after removing the drawers or baskets for cleaning, be sure to load the unit from the bottom drawer or basket up to ensure the components are seated properly. (Applicable for drawers and baskets only).

9 Operation

9.1 Control Panel

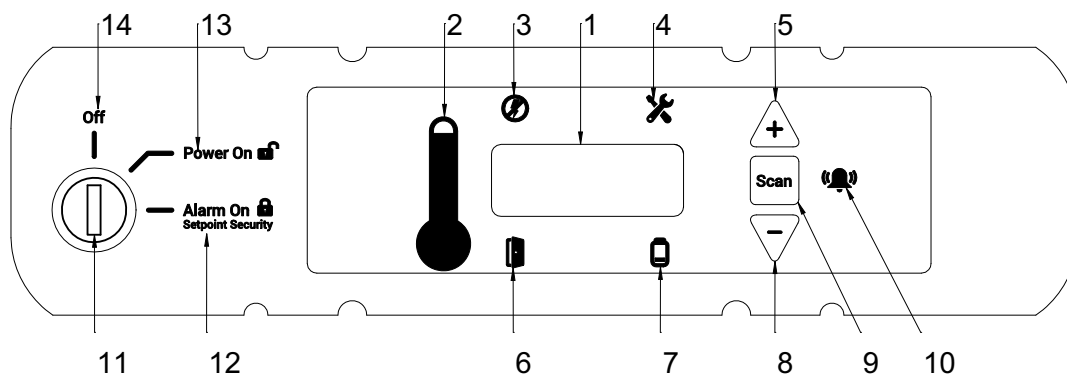

Figure 11. Freezer Control Panel

The control panel is located on the top right side of your freezer. You can use the three pushbuttons (#5, #8, and #9 in *Figure 11*) to change the temperature display (#1) or to adjust temperature and alarm setpoints as given in *Section 9.3*. The thermometer display (#2) provides a quick visual indicator of current cabinet temperature and alarm conditions.

1. **Main temperature display** - during normal operation, shows cabinet temperature in degrees Celsius, as measured by the primary sensor inside the cabinet. You can use the buttons to display other values such as setpoints, highest and lowest recorded temperatures. The number in the main display flashes when the value can be modified.
2. **Thermometer** - shows cabinet temperature and alarm conditions. There are 10 horizontal bars: 9 are displayed during normal operation, the tenth (top) bar indicates a warm alarm condition. The number of bars illuminated indicates approximate cabinet temperature. With the default settings, 4 to 6 bars illuminated indicate that the cabinet is at desired setpoint. For example, suppose that the cabinet temperature setpoint is -20°C and that the warm and cold alarm setpoints are -25°C and -15°C . Then the number of bars illuminated indicates cabinet temperature as follows:

Table 6. Thermometer Display on Control Panel (Setpoint -20°C)

Bars Displayed	Temperature (°C)	Bars Displayed	Temperature (°C)
Bulb Only	-25 (cold alarm)	6 Bars	-19
1 Bar	-24	7 Bars	-18
2 Bars	-23	8 Bars	-17
3 Bars	-22	9 Bars	-16
4 Bars	-21	10 Bars	-15 (warm alarm)
5 Bars	-20		

When cabinet temperature exceeds the warm alarm setpoint, the top bar of the thermometer flashes. When temperature is lower than the cold alarm setpoint, the bulb flashes. When you are in programming mode (described in *Table 8*) the thermometer shows the setpoint value you are changing.





3. **Power failure** - illuminates when the main power supply is interrupted. In this case the audible alarm also sounds.
4. **Service mode** - illuminates when the controller is in service programming mode.
5. **Increase** - pushbutton used to increase setpoint values in programming mode and for various display functions.
6. **Door ajar** - illuminates when the freezer door is open longer than 3 minutes (when the alarm is activated and the key switch is turned to the alarm position).
7. **Battery low** - illuminates when the backup battery is low (refer to *Section 12.6*).
8. **Decrease** - pushbutton used to decrease setpoint values in programming mode and for various display functions.
9. **Scan** - pushbutton used to change the main display and for various other functions.
10. **Audible alarm** - illuminates during warm and cold alarm conditions.

11. **Key Switch** - switch used to turn the power and alarms on and off for the unit.
12. **Alarm On** - Setpoint Security - when the key switch is in the alarm on position, the alarms are on and the setpoints cannot be modified.
13. **Power On** - when the key switch is in the on position, the unit power is on with no alarms active.
14. **Off** - when the key switch is in the off position, the unit is off.

For full descriptions of display, programming and service functions, refer to *Tables 7, 8, and 9.*

9.2 Display Functions

Table 7. Control Panel Display Functions

Function	Meaning	Sequence	Display
Normal operation	Default display while freezer is running.		Temperature display and control panel thermometer icon show cabinet temperature.
Coldest logged temperature	Show coldest cabinet temperature since last startup or reset.	Press 	Display shows coldest logged temperature while button is pressed.
Warmest logged temperature	Show warmest cabinet temperature since last startup or reset.	Press 	Display shows warmest logged temperature while button is pressed.
Mute	Silence audible alarm for 6 minutes.	Press 	Display and thermometer show cabinet temperature, alarm icon continues to flash.
Reset	Return to default display after alarm condition, clears temperature log.	Press  and  simultaneously, hold for 5 seconds.	Excursion values are reset; temperature display shows cabinet temperature.

9.3 Programming Functions

You can enter the programming mode by pressing the Scan button (Scan) and holding for 5 seconds. The display will then flash "Prg" to indicate that you have entered the programming mode. Use (▲) and (▼) buttons to modify the values and press the scan (Scan) button to save the value and go to the next screen.

Table 8. Setpoint Programming Functions

Screen/Button		Function	Summary
1	Initial Screen	Unit Set point	The temperature that the unit is set to run
2	Press Scan (Scan)	Cold Alarm Temperature	The temperature that will actuate the cold alarm (if active)
3	Press Scan (Scan)	Warm Alarm Temperature	The temperature that will actuate the warm alarm (if active)
4	Press Scan (Scan)	Exit Program Mode	Returns to normal operating screen

If the unit is left idle for a period of 30 seconds during program mode, the program mode shall be exited.

If at any point the scan button is pressed and held for a period of 10 seconds, the unit shall enter the service mode.

9.4 Service Parameters









You can enter the service mode by pressing the Scan button (Scan) and holding for 10 seconds while in Programming mode (refer to *Section 9.3*). The display will then flash "Ser" to indicate that you have entered the service mode followed by the software checksum values flashing on the screen. The service icon (✘) will also illuminate. Use up (▲) and down (▼) buttons to modify the values and press the scan (Scan) button to save the value and go to the next screen.

Note If the alarms are enabled, all parameters are read only and cannot be edited.



CAUTION: Resetting any of the following parameter values could adversely affect the performance of your freezer. Be sure to understand your product requirements prior to making any adjustments to the service parameter values.

Table 9: Service Parameters

Screen/Button		Display	Function	Summary
1	Initial Screen	20	Temp of unit	Allows the user to see what temperature the unit is designed to run
		Varies	CPU Checksum	Shows the current checksum of the CPU board for validation
		Varies	Relay Board Checksum	Shows the current checksum of the Relay board for validation
		0.0	Display Offset	Allows the user to create offset in the temperature displayed. This can be useful to adjust display to correlate with calibration.
2	Press Scan ()	Cnt ucl	Control Upper Hysteresis	The degree increase in temperature from the set point that will trigger the unit to begin cooling to prevent the unit from getting too warm.
3	Press Scan ()	Cnt lcl	Control Lower Hysteresis	The degree decrease in temperature from the set point that will trigger the unit to stop cooling to prevent the unit from getting too cold.
4	Press Scan ()	Qua	Quality Mode	Normally OFF(00). Used for production line testing.
5	Press Scan ()	bot	BOT Mode	Normally OFF(00). If ON(01), the unit is forced to run at coldest possible temperature for 24 hours. Defrosts will still occur as scheduled.
6	Press Scan ()	Per	Perimeter Heater Duty Cycle	Controls the perimeter heater ON time.
7	Press Scan ()	Cnt Prb	Control Probe Temperature	Displays control probe temperature (Read only).
8	Press Scan ()	Anb Prb	Ambient Probe Temperature	Displays ambient probe temperature in deck (Read only).
9	Press Scan ()	-	Enter Defrost cycle	Pressing the Scan button after displaying the defrost probe temperature while not in an alarm mode will force the unit into a defrost cycle. To avoid defrost cycle, leave unit screen idle for 30 seconds.

If the unit is left idle for a period of 30 seconds during service mode, the unit will exit service mode and return to normal operation.

Note If an alarm occurs while in the service mode, it will not show until exiting this mode.

To reset values back to factory settings, perform the following procedure:

1. Turn keyswitch to “OFF” position.
2. Hold the up (▲) and down (▼) arrows while turning the keyswitch to the “ON” position.
3. Continue to hold buttons for 10 seconds.
4. Release buttons and turn keyswitch to “OFF” position.
5. Turn keyswitch to “ON” position.



CAUTION: Performing this reset will overwrite any changes that were made after the receipt of this unit.

9.5 Temperature Settings

The factory default temperature setting is -20°C for all manual defrost freezers, including enzyme freezers. To change the factory temperature settings, refer to the instructions in *Section 9.3*.



CAUTION: The freezer described in this manual is designed for optimum performance at -20°C. It is advisable to call Technical Service before changing setpoints.

9.6 Alarms

The alarm system is designed to provide visual and audible warning signals for both power failure and rise in temperature. The alarm is equipped with a battery backup.

Default cold and warm alarm values are -25°C and -15°C. These values may be adjusted, following instructions in *Section 9.3*.

The alarm system is activated only when the key switch is turned to the Alarm On position. The audible warning signal sounds when there is a power failure, temperature alarm condition, or when the door is ajar for more than 3 minutes.

The Mute function (pressing the (Scan) button) allows you to turn off the audio warning without turning off the visual indicators. The alarm will ring back approximately after 6 minutes if the alarm is still active.



During a warm alarm, a flashing of the uppermost bar of the thermometer, the temperature display, and the speaker icon will occur at the same time.

If there has been a warm alarm since the last alarm reset, but the temperature is not currently in an alarm state, the uppermost bar of the thermometer and the speaker icon will slowly alternate in flashing.

During a cold alarm, a flashing of the bulb of the thermometer, the temperature display, and the speaker icon will occur at the same time. If there has been a cold alarm since the last alarm reset, but the temperature is not currently in an alarm state, the bulb of the thermometer and the speaker icon will slowly alternate in flashing.

During a power failure, the power failure icon will illuminate, the thermometer will display without the bulb, and the temperature will flash approximately every 6 seconds. If there has been a power failure since the last alarm reset, the power failure icon and the speaker icon will slowly alternate in flashing.

During a low battery condition, the low battery icon will illuminate.

The alarms can be reset by pressing and holding the  and  simultaneously.

10 Chart Recorder (Optional)

Panel-mounted six inch recorders are standard and factory-installed option. Recorder operation begins when the system is powered on.

10.1 Set Up and Operation

To prepare the recorder to function properly, complete the following steps:

1. Open the recorder door to access the recorder.
2. Connect the nine volt DC battery located at the recorder's upper right corner. This battery provides back-up power.
3. Install clean chart paper (refer to *Section 10.2* below).
4. Close the recorder door.



Note The recorder may not respond until the system reaches temperatures within the recorder's range.

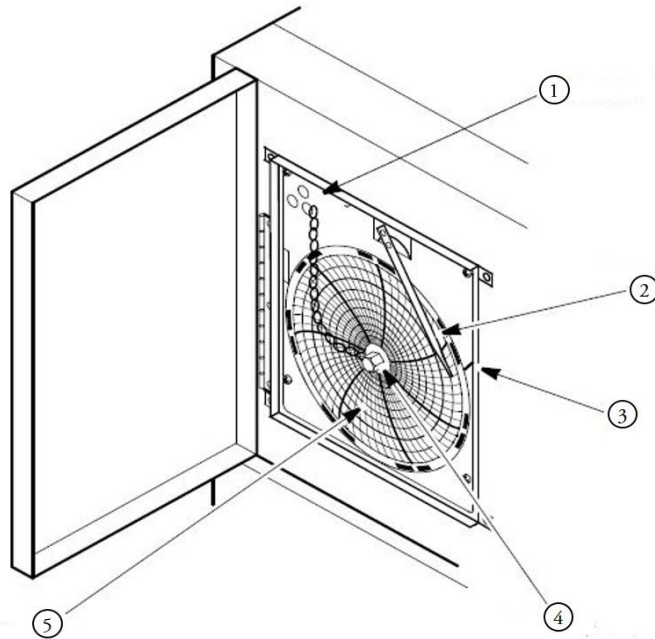

Figure 12. Chart Recorder

Label	Description
1	Pressure Sensitive Chart Buttons
2	Imprinting Stylus
3	Reference Mark
4	Hub-Nut and Retaining Wire
5	Chart

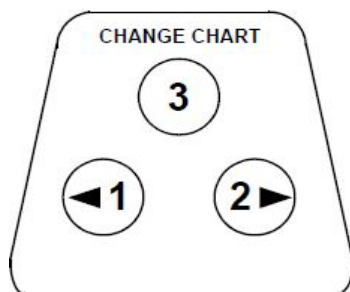

Figure 13. Chart Buttons

10.2 Changing Chart Paper

To change the chart paper, complete the following steps:

1. Locate the pressure sensitive buttons at the front, upper left of the recorder panel.
2. Press and hold the change chart button (#3 in *Figure 13*) for one second. The pen will move off the scale.
3. Unscrew the center nut, remove the old chart paper, and install new chart paper. Carefully align the day and time with the reference mark on the recorder panel (a small groove on the left side of the panel, as shown in *Figure 12*).
4. Replace the center nut and hand tighten. Press the change chart button again (#3) to resume temperature recording.



Note Be careful not to pull up on the chart recorder arm while changing paper. Pulling on the arm may damage the recorder.



CAUTION: Do not use sharp or pointed objects to depress the chart buttons. This may cause permanent damage to the recorder.

10.3 Power Supply

The recorder normally uses AC power when the system is operating. If AC power fails, the LED indicator on the recorder flashes to alert you to a power failure. The recorder continues sensing cabinet temperature and the chart continues turning for approximately 24 hours with back-up power provided by the nine-volt battery.

The LED indicator glows continuously when main power is functioning and the battery is charged.

When the battery is low, the LED flashes to indicate that the battery needs to be changed.

10.4 Calibration and Adjustments

This recorder has been accurately calibrated at the factory and retains calibration even during power interruptions. If required, however, adjustments can be made as follows:

1. Run the unit continuously at the control setpoint temperature. Continue steady operation for at least two hours to provide adequate time for recorder response.
2. Measure cabinet center temperature with a calibrated temperature monitor.
3. Compare the recorder temperature to the solution temperature. If necessary, adjust the recorder by pressing the left and right chart buttons (#1 and #2 from *Figure 13*) for 5 seconds.



Note The stylus does not begin to move until the button is held for 5 seconds.

11 Temperature Transmitter

A powered temperature transmitter is standard on this unit. This temperature transmitter allows for remote temperature monitoring of your system.

To connect your remote temperature monitoring system to the temperature transmitter, refer to *Figure 14* below:

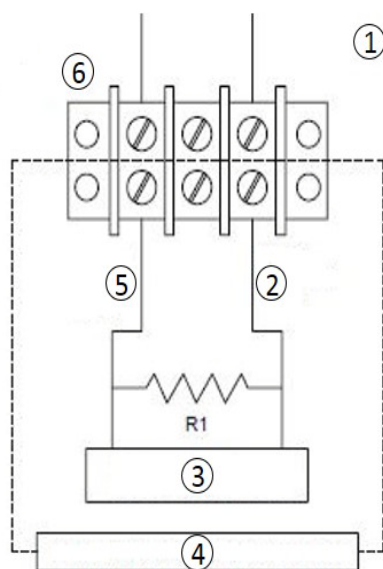

Figure 14. Temperature Transmitter

Label	Description
1	Rear of Unit
2	16.5V Supply Negative
3	Controller and/or Indicator
4	Customer Provided System
5	Temperature Transmitter Negative
6	Terminal Strip

12 Maintenance



WARNING: Disconnect equipment from main power before attempting any maintenance to equipment or its controls unless stated otherwise.

12.1 Cleaning the Cabinet Interior

To clean the cabinet interior, remove the shelves, drawers, or baskets following the instructions in *Section 7.4*, *Section 7.5* and *Section 7.6*. Use a solution of water and a mild detergent for cleaning. Rinse the interior storage components and wipe them dry with a soft cloth.

12.2 Cleaning the Condenser Filter

Clean the condenser filters every three months. There is one condenser filter located in the back cage of the unit that can be accessed without removing the back cage or disconnecting the power.

To clean the filter, complete the following steps:

1. Remove the filter by pulling upwards through the slot in the back cage.
2. Shake the filter to remove loose dust.
3. Rinse the filter in clean water.
4. Shake the excess water from the filter and let it dry.
5. Reinstall filter by pushing downwards through the slot in the back cage.



CAUTION: Do not pull the filter downwards from the bottom. The condenser has sharp surfaces.

12.3 Cleaning the Condenser



CAUTION: Condensers should be cleaned at least every six months; more often if the laboratory area is dusty. In heavy traffic areas, condensers load with dirt more quickly. Failure to keep the condenser clean can result in equipment warm-up or erratic temperatures.



CAUTION: Never clean around the condensers with your fingers. Some surfaces are sharp.

The condenser is located in the top rear of the machine compartment. To clean the condenser, complete the following steps:

1. Disconnect the power.
2. Remove the filter.
3. Vacuum the condenser and clean up any loose dust.
4. Replace the filter.
5. Reconnect power.

12.4 Defrost

You should defrost the freezer whenever there is significant frost buildup inside the cabinet.

To defrost:

1. Remove all products and place in another cold storage medium.
2. Turn off the unit and allow the interior to warm to room temperature. Leave the door ajar to shorten defrost time.
3. Dispose of the ice and wipe out any water standing in the bottom of the cabinet.



CAUTION: When defrosting your freezer, never use sharp or heavy tools such as chisels or scrapers. Damage to the equipment can result. Let the ice melt enough so that it can be easily removed.

If there is freezer odor, wash the interior with a solution of baking soda and warm water. Clean the exterior with any common household cleaning solution.

12.5 Gasket Maintenance

Periodically check the gaskets around the door for punctures or tears. Leaks are indicated by condensation or frost which form at the point of gasket failure. Make sure that the cabinet is level (refer to *Section 7.2* for leveling information).

Keep the door gaskets clean and frost free by wiping gently with a soft cloth.

To check the door seal, complete the following steps:

1. Open the door.
2. Insert a strip of paper (a couple of inches wide) between the door gasket and the cabinet flange and close the door.
3. Slowly pull the paper strip from the outside. You should feel some resistance.
4. Repeat this test at 4-inch intervals around the door. If the door does not seal properly, replace the gasket.

12.6 Alarm Battery Maintenance

Have a certified technician replace the alarm battery every twelve months at most or when the alarm is active. The part number for a replacement battery is 322533H01.

13 Troubleshooting



WARNING: Troubleshooting procedures involve working with high voltages which can cause injury or death. Troubleshooting should only be performed by trained personnel.

This section is a guide for troubleshooting equipment problems.

Table 10. Troubleshooting Procedures

Problem	Cause	Solution
Unit does not operate or Power Failure Indicator is on	Power supply	<p>Check that the cord is securely plugged in.</p> <p>Plug another appliance into the outlet to see if it is live.</p> <p>Check that the double pole circuit breaker located next to the power inlet is in "ON" position (i.e. "1" position). Try cycling to OFF position (i.e. "0" position) & then bring to ON ("1") position.</p> <p>Test the voltage and verify that it is correct for your unit (refer to <i>Table 2</i>).</p> <p>If the outlet is dead, check the circuit breaker or fuses.</p>
Temperature fluctuates	Temperature Control	Make sure that the control is set correctly. Refer to <i>Section 9.3</i> .
	Condenser clogged	Make sure the condenser and filter are clean. Refer to <i>Section 12.2</i> and <i>Section 12.3</i> .
	Other causes	If the temperature control is set correctly, the condenser is clean, but temperature continues to fluctuate, call an authorized service representative.
Low battery icon is lit	12V backup battery needs to be replaced.	Replace the battery. It is located on the top right hand side of the cabinet. Call an authorized service representative.
Unit warms up	Door is open	Make sure the door is completely closed.
	Door seal	Check the door seal, following instructions in <i>Section 12.5</i> .
	Warm product recently loaded in unit	Allow ample time to recover from loading warm product.
	Power supply	Check for proper voltage to the unit. If there is no voltage to the unit, call an electrician.
	Setpoints need to be adjusted	To adjust the setpoint, refer to <i>Section 9.3</i> .
"E01" on display	Communication error	Call customer service.
"E02" on display	Control Probe Failure	Check for loose probe connector. Replace control probe.

Table 10. Troubleshooting Procedures

Problem	Cause	Solution
"E05" on display	Ambient Probe Failure	Check for loose probe connector. Replace ambient probe.
"---" on display	Lost Communication	Call customer service.

14 End of Life Care

Be sure to follow local regulations when disposing of an old unit. Some suggestions are listed in the following.

1. Remove items and defrost unit. Be sure to clean up any biological safety hazards.
2. Remove the cabinet door to help prevent entrapment inside of a unit.
3. Have a certified technician remove the refrigerant and compressor, then drain the compressor and oil from the system. Dispose of components following local regulations.

15 Warranty

Domestic Warranty • 24 Months Full Warranty Parts and Labor

International Warranty • 24 Months Full Warranty Parts Only

During the first twenty four (24) months from shipment, Thermo Fisher Scientific Inc, through its authorized Dealer or service organizations, will at its option and expense repair or replace any part found to be non-conforming in material or workmanship. Thermo Fisher Scientific Inc reserves the right to use replacement parts, which are used or reconditioned. Replacement or repaired parts will be warranted for only the unexpired portion of the original warranty.

This warranty does not apply to damage caused by (i) accident, misuse, fire, flood or acts of God; (ii) failure to properly install, operate or maintain the products in accordance with the printed instructions provided, (iii) causes external to the products such as, but not limited to, power failure or electrical power surges, (iv) improper storage and handling of the products, (v) use of the products in combination with equipment or software not supplied by Thermo Fisher; or (vi) installation, maintenance, repair, service, relocation or alteration of the products by any person other than Thermo Fisher or its authorized representative. To obtain proper warranty service, you must contact the nearest authorized service center or Dealer. ThermoFisher Scientific, Inc's own shipping records showing date of shipment shall be conclusive in establishing the warranty period. At Thermo Fisher's option, all non-conforming parts must be returned to Thermo Fisher postage paid and replacement parts are shipped FOB Thermo Fisher's location.

Limitation of Liability

THIS WARRANTY IS EXCLUSIVE AND IN LIEU OF ALL OTHER WARRANTIES, WHETHER WRITTEN, ORAL, OR IMPLIED. NO WARRANTIES OF MERCHANTABILITY OR FITNESS FOR A PARTICULAR PURPOSE SHALL APPLY. THERMO FISHER DOES NOT WARRANT THAT THE PRODUCTS ARE ERROR-FREE OR WILL ACCOMPLISH ANY PARTICULAR RESULT.

THERMO FISHER SHALL NOT BE LIABLE FOR ANY INDIRECT OR CONSEQUENTIAL DAMAGES INCLUDING, WITHOUT LIMITATION, DAMAGES TO LOST PROFITS OR LOSS OF PRODUCTS.

WEEE Compliance

WEEE Compliance. This product is required to comply with the European Union's Waste Electrical & Electronic Equipment (WEEE) Directive 2012/19/EU. It is marked with the following symbol. Thermo Fisher Scientific has contracted with one or more recycling/disposal companies in each EU Member State, and this product should be disposed of or recycled through them. Further information on our compliance with these Directives, the recyclers in your country, and information on Thermo Scientific products which may assist the detection of substances subject to the RoHS Directive are available at www.thermo.com/

Great Britain



WEEE Konformität. Dieses Produkt muss die EU Waste Electrical & Electronic Equipment (WEEE) Richtlinie 2012/19/EU erfüllen. Das Produkt ist durch folgendes Symbol gekennzeichnet. Thermo Fisher Scientific hat Vereinbarungen getroffen mit Verwertungs-/Entsorgungsanlagen in allen EU-Mitgliederstaaten und dieses Produkt muss durch diese Firmen wiederverwertet oder entsorgt werden. Mehr Informationen über die Einhaltung dieser Anweisungen durch Thermo Scientific, die Verwerter und Hinweise die Ihnen nützlich sein können, die Thermo Fisher Scientific Produkte zu identifizieren, die unter diese RoHS. Anweisung fallen, finden Sie unter www.thermo.com/

Deutschland



Conformità WEEE. Questo prodotto deve rispondere alla direttiva dell'Unione Europea 2012/19/EU in merito ai Rifiuti degli Apparecchi Elettrici ed Elettronici (WEEE). È marcato col seguente simbolo. Thermo Fisher Scientific ha stipulato contratti con una o diverse società di riciclaggio/smaltimento in ognuno degli Stati Membri Europei. Questo prodotto verrà smaltito o riciclato tramite queste medesime. Ulteriori informazioni sulla conformità di Thermo Fisher Scientific con queste Direttive, l'elenco delle ditte di riciclaggio nel Vostro paese e informazioni sui prodotti Thermo Scientific che possono essere utili alla rilevazione di sostanze soggette alla Direttiva RoHS sono disponibili sul sito www.thermo.com/

Italia



Conformité WEEE. Ce produit doit être conforme à la directive euro-péenne (2012/19/EU) des Déchets d'Equipements Electriques et Electroniques (DEEE). Il est marqué par le symbole suivant. Thermo Fisher Scientific s'est associé avec une ou plusieurs compagnies de recyclage dans chaque état membre de l'union européenne et ce produit devrait être collecté ou recyclé par celles-ci. Davantage d'informations sur la conformité de Thermo Fisher Scientific à ces directives, les recycleurs dans votre pays et les informations sur les produits Thermo Fisher Scientific qui peuvent aider la détection des substances sujettes à la directive RoHS sont disponibles sur www.thermo.com/

France



IF YOU NEED ASSISTANCE:

Thermo Fisher Scientific products are backed by a global technical support team ready to support your applications. We offer cold storage accessories, including remote alarms, temperature recorders, and validation services. Visit www.thermofisher.com or call:

Phone Numbers	Sales	Service
North America	+1 866 984 3766	(800) 438-4851
India	1800 22 8374, +91 22 6716 2200	+91 22 6716 2200
China	+800 810 5118, +400 650 5118	+8621 68654588
Japan	+81 3 5826 1616	+81 3 3816 3355
Australia	+61 39757 4300	1 300 735 292
Austria	+43 1 801 40 0	+43 1 801 40 0
Belgium	+32 53 73 42 41	+32 2 482 30 30
France	+33 2 2803 2180	+33 2 2803 2180
Germany	0800 1 536 376, +49 6184 90 6000	0800 1 536 376
Italy	+32 02 95059 552	+39 02 95059 552, 432 254 375
Netherlands	+31 76 579 55 55	+31 76 571 4440
Nordic/Baltic	+358 9 329 10200	+358 9 329 100
Russia/CIS	+7 812 703 4215	+7 812 703 4215
Spain/Portugal	+34 93 223 09 18	+34 93 223 09 18
Switzerland	+41 44 454 12 22	+41 44 454 12 12
UK/Ireland	+44 870 609 9203	+44 870 609 9203
New Zealand	+64 9 980 6700	+64 9 980 6700
Other Asian countries	+852 2885 4613	+852 2885 4613
Countries not listed	+49 6184 90 6000	+49 6184 90 6000

Thermo Fisher Scientific Inc.

275 Aiken Road
Asheville, NC 28804
United States

www.thermofisher.com